



SECTION 3

ELECTRONIC CONTROL SYSTEM INFORMATION

WINE STORAGE ELECTRONIC CONTROL TERMINOLOGY & COMPONENT DESCRIPTIONS:

All 400 Series units utilize an electronic control system. The electronic control system monitors, regulates and controls a variety of functions. This system also displays temperatures, possible problems with the unit and the bell status. The table below defines some basic electronic control system terminology and describes some of the electronic control components. An understanding of the following information is needed in order to comprehend the electronic control system.

NOTE: The refrigerator section of the model 427R uses a separate and unique electronic control system. See 427R REFRIGERATOR ELECTRONIC CONTROL TERMINOLOGY & COMPONENT DESCRIPTIONS.

| <u>Term/Component</u> | <u>Definition / Description</u> |
|---------------------------------------|---|
| Control Board | The printed-circuit board (PC Board) contains the microprocessor, relays and electrical connections which control and monitor all functions and operations of the unit. |
| Microprocessor | An electrical component on the control board which receives electrical signals from other components, processes that information, then sends an electrical signal to the relays on the board to open or close, and other electronic components in the unit to switch on or off. |
| Relay | The electrical components on the control board which close or open to either allow power to the appropriate component(s), or interrupts power from reaching appropriate component(s). |
| LED (Light Emitting Diode) | For our purposes, this is a small electronic "tube" that lights-up when power is supplied to it. In the control panel assembly, LED's are arranged to show temperature values (numbers). LED's are also used in the control panel assembly as back-lighting for the compartment indicator arrows and the "BELL" and "SERVICE" annunciators. |
| Control Panel Assembly | The information input and read-out area of the electronic control system, located between the two wine storage compartments. NOTE: The 427R has two control panel assemblies, the second is located inside the top drawer assembly, at top front. |
| Membrane Switch | An integral part of the control panel assembly, which consists of the function keys used for all input functions to the electronic control system. |
| Keys (Function Keys) | The buttons on the Membrane switch used for input functions. (The keys are: UNIT ON/OFF, LIGHTS ON/OFF, ALARM ON/OFF, COLDER, WARMER) |
| Annunciators | The words and numbers that are displayed/lighted on the control panel assembly. (Example: Temperature readings, BELL indicator and SERVICE indicator) |
| Set-Point | The desired compartment temperature. This is the approximate average of the high offset and the low offset. |
| High Offset (Cut-in)..... | During normal operation of a wine storage unit, this is the maximum evaporator temperature that the electronic control system will allow before calling for cooling. |
| Low Offset (Cut-out)..... | During normal operation of a wine storage unit, this is the minimum compartment air temperature that the electronic control system will allow before interrupting cooling. |
| Offset Temperature Range | The difference between the low offset and the high offset. |
| Thermistor (Temperature Sensor) | A resistor with which resistance changes as the temperature around it changes. For electronic control system purposes, the microprocessor deciphers this resistance as temperature. |

BASIC WINE STORAGE ELECTRONIC CONTROL SYSTEM:

Input operations for the Wine Storage electronic control system are performed at the control panel, with monitoring, regulating and controlling functions taking place at the control board. Temperatures and possible problems with the unit are illuminated at the control panel with LED's. The diagrams on this page illustrate the wine storage electronic control system. (See Figure 3-1 for units prior to serial #1944319, see Figure 3-2 for units starting with serial #1944319.) The entire electronic control system is described in greater detail following in this page.

NOTE: The refrigerator section of the model 427R uses a separate and unique electronic control system. See **MODEL 427R REFRIGERATOR BASIC ELECTRONIC CONTROL SYSTEM.**

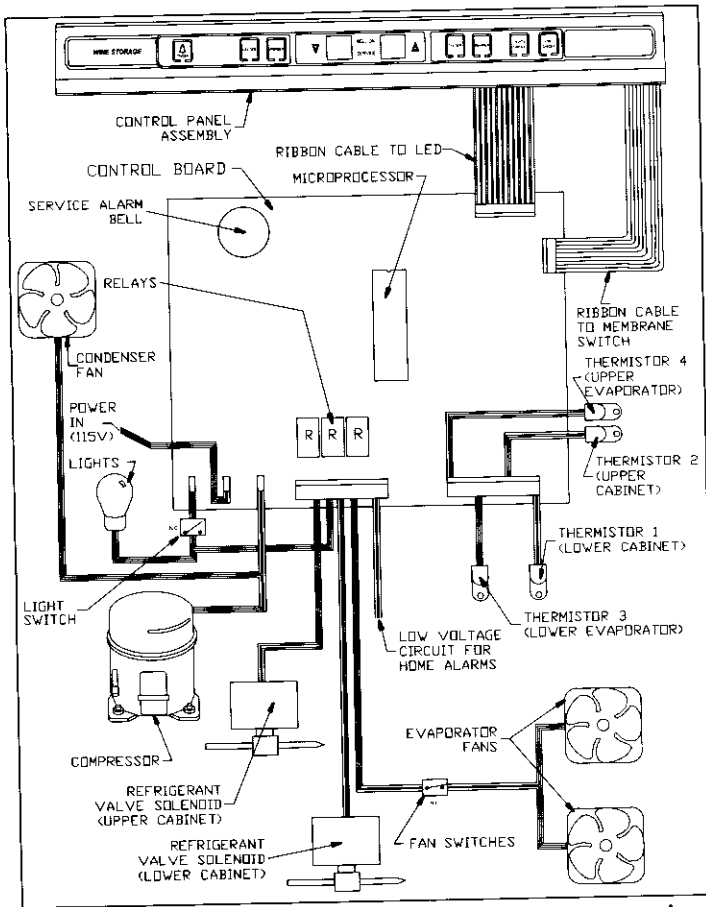

Figure 3-1. Basic Wine Storage Electronic Control System, Prior to Serial #1944319

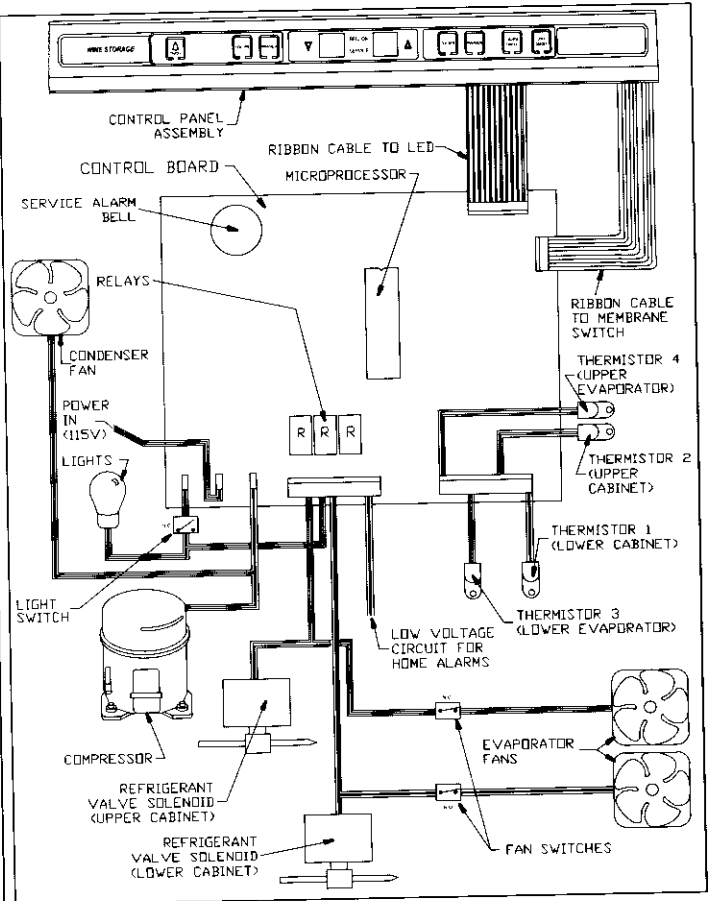

Figure 3-2. Basic Wine Storage Electronic Control System, Starting w/Serial #1944319

WINE STORAGE CONTROL BOARD LAYOUT AND SUMMARY TABLE:

The electrical connection points on the wine storage control board are labeled Alphanumerically. These labels correspond with the alphanumeric control board summary table, located on all 400 Series wiring diagram. By referencing the summary table, it is possible to identify which components are connected at which connection points on the control board. Below is a layout diagram of the control board, followed by a copy of a summary table. (See Figures 3-3 and 3-4)

NOTE: All components on the control board are non-replaceable. If a problem with the control board is identified, the complete control board must be replaced.

NOTE: The refrigerator section of the model 427R uses a separate and unique electronic control system. See MODEL 427R REFRIGERATOR CONTROL BOARD LAYOUT / SUMMARY TABLE.

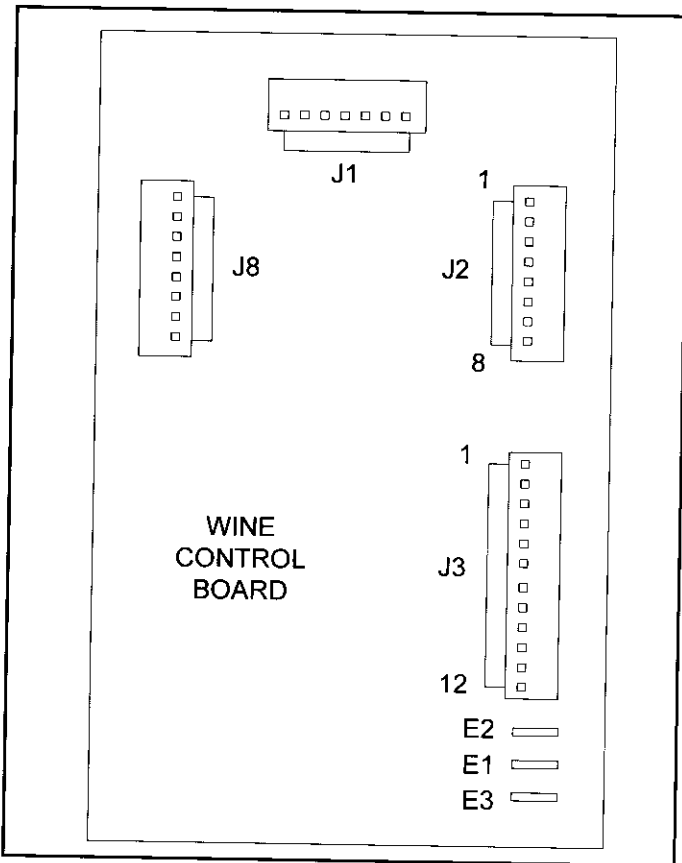

Figure 3-3. Wine Storage Control Board Layout

400 SERIES CONTROL BOARD SUMMARY / LAYOUT

| CIRCUIT | DESCRIPTION | FUNCTION | COLOR | DESCRIPTION | FUNCTION | COLOR |
|---------|----------------------|-------------------------|--------|------------------------------------|--------------------|-------------|
| E1 | 120 VOLT CIRCUITS | | | LOW VOLTAGE CIRCUITS | | |
| E2 | POWER INTO BOARD | | BLACK | J3 ALARM CIRCUIT | | |
| E3 | COMPRESSOR | POWER INTO BOARD | GRAY | P1 ALARM CIRCUIT - COMMON | FOR HOME ALARMS | WHIT/RED |
| J1 | POWER LIGHTS | POWER LIGHTS | BROWN | P2 ALARM CIRCUIT - NORMALLY CLOSED | FOR HOME ALARMS | WHIT/BLUE |
| J2 | GROUND | EARTH GROUND | GREEN | P3 ALARM CIRCUIT - NORMALLY OPEN | FOR HOME ALARMS | GRAY/WHIT |
| P1 | EMPTY | | | J2 THERMISTOR CIRCUITS | | |
| P2 | NEUTRAL | NEUTRAL INTO BOARD | WHITE | P1 LOWER CABINET | SENSES TEMPERATURE | BLUE/WHITE |
| P3 | EMPTY | | | P2 LOWER CABINET | SENSES TEMPERATURE | BLUE/WHITE |
| P4 | UPPER SOLENOID VALVE | COOLS UPPER COMPARTMENT | GRAY | P3 UPPER CABINET | SENSES TEMPERATURE | BLUE/BLACK |
| P5 | LIGHTS OVERRIDE | ON WHEN LIGHTS ON 100% | ORANGE | P4 LOWER EVAPORATOR | SENSES TEMPERATURE | BLUE/BLACK |
| P6 | LOWER SOLENOID VALVE | COOLS LOWER COMPARTMENT | BLUE | P5 UPPER EVAPORATOR | SENSES TEMPERATURE | ORANGE/RED |
| P7 | EVAPORATOR FANS | POWER EVAPORATOR FANS | YELLOW | P6 LOWER EVAPORATOR | SENSES TEMPERATURE | BLUE/YELLOW |
| P8 | EMPTY | | | P7 UPPER EVAPORATOR | SENSES TEMPERATURE | ORANGE/YELL |

Figure 3-4. Wine Storage Control Board Summary Table

WINE STORAGE CONTROL PANEL LAYOUT:

NOTE: The refrigerator section of the model 427R uses a separate and unique electronic control system, which includes the control panel. See MODEL 427R REFRIGERATOR CONTROL PANEL LAYOUT.

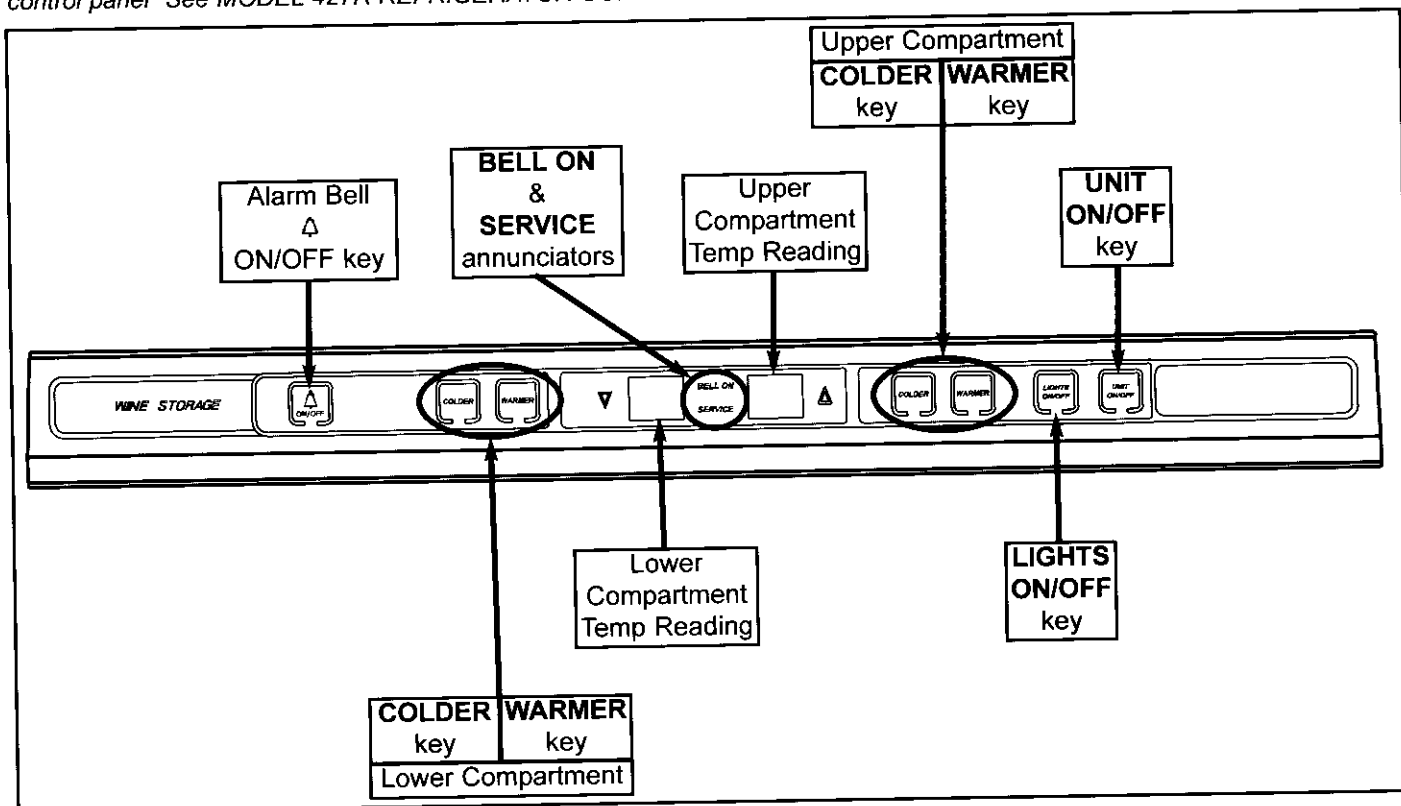

Figure 3-5. Wine Storage Control Panel Layout

BASIC WINE STORAGE ELECTRONIC CONTROL INPUT OPERATIONS:

This section illustrates the basic input operations performed at the wine storage control panel. Switching the unit ON and OFF, adjusting the set-point (temperature adjustments), switching the lighting system ON and OFF, and enabling and disabling the alarm BELL will be explained.

NOTE: The refrigerator section of the model 427R uses a separate and unique electronic control system. See 427R REFRIGERATOR BASIC ELECTRONIC CONTROL INPUT OPERATIONS.

Unit ON/OFF

All 400 Series units are shipped in the Off Mode. By pressing and releasing the UNIT ON/OFF key, (See Figure 3-6) power is allowed past the control board to the rest of the unit. This will be indicated by the unit lights and LED's in the display energizing.

⚠ WARNING

WHEN IN OFF MODE, 115 VOLTS AC IS STILL PRESENT AT CONTROL BOARD.

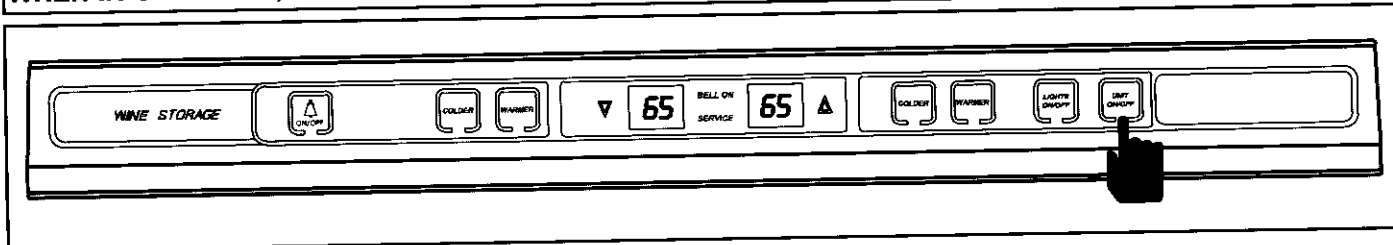

Figure 3-6. Unit ON/OFF, Press UNIT ON/OFF Key

Adjusting Wine Storage Set-Points (Temperature Adjustments)

To adjust set-points, press the WARMER or COLDER keys for the appropriate compartment in multiple key strokes until the desired temperature is achieved. (See Figure 3-7)

NOTE: To check what the set point is, press either the WARMER or COLDER key, keeping in mind that the initial key stroke will change the previous set-point by a one degree increment or decrement depending on your key stroke choice.

NOTE: The set-point will be displayed for 10 seconds after the last WARMER or COLDER key stroke. After the 10 second delay, the compartment temperature will be displayed. As the compartment temperature changes, the temperature displayed will change by no more than 1° per minute.

NOTE: The temperature range in a wine storage compartment is 38°F / 3°C to 65°F / 18°C. The temperature range in the refrigerator drawer section of a 427R is 34°F / 1°C to 45°F / 7°C.

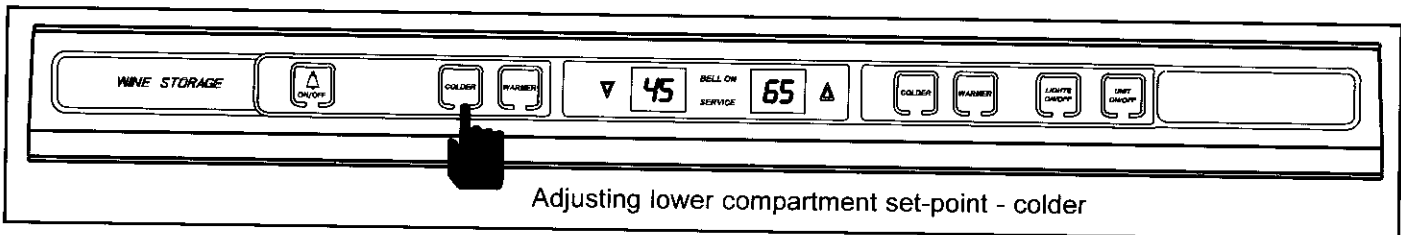

Figure 3-7. Adjusting Set-Point, Press COLDER or WARMER Keys

Wine Storage Lighting System ON/OFF

For the purpose of displaying a wine supply in a 400 Series unit, it is possible to energize the lights to stay ON 100% of the time, even if the door is closed. To do this, press and release the LIGHTS ON/OFF key. (See Figure 3-8) To disable this feature so that the lights are energized only when the door is open, simply press and release the LIGHTS ON/OFF key again.

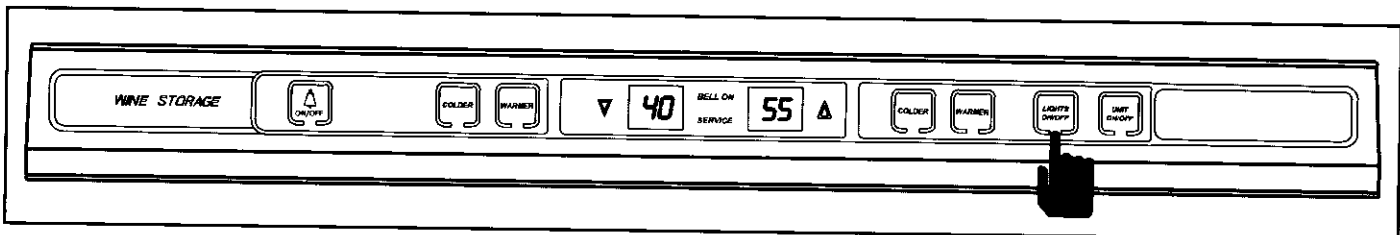

Figure 3-8. Light System ON/OFF, Press LIGHTS ON/OFF Key

Wine Storage Alarm "BELL" ON/OFF (Temperature alarm)

The 400 series has an audio/visual temperature alarm that can be enabled to warn the customer if the unit is experiencing excessive warm or excessive cold temperatures. To enable the alarm, press and release the key with the bell on it. (See Figure 3-9) If the alarm is enabled, the BELL ON annunciator will illuminate. To disable the alarm, simply press and release the key with the bell on it again, and the BELL ON annunciator will de-energize.

NOTE: If the alarm bell is enabled and there is a temperature problem, the BELL ON annunciator will flash and the audible alarm will beep. The alarm feature can also be tied in with a home security alarm system. This will be explained later in this manual.

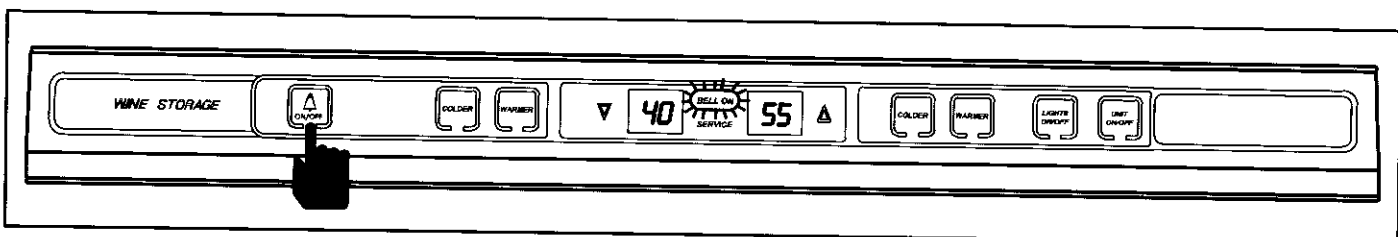

Figure 3-9. Alarm Bell ON/OFF, Press  (Alarm Bell) ON/OFF Key

FUNCTION OF THE WINE STORAGE ELECTRONIC CONTROL SYSTEM:

This section explains the monitoring, regulating and controlling functions of the wine storage electronic control system. The electronic control system in the refrigerator section of the model 427R will be explained later in this manual.

NOTE: All electronic control functions described in this section are normal operation only. For possible malfunctions, see *WINE STORAGE TEMPERATURE ALARM FEATURE AND POSSIBLE ERROR INDICATORS* : section, the *WINE STORAGE DIAGNOSTIC MODE* and the *TROUBLESHOOTING GUIDE*.

NOTE: The refrigerator section of the model 427R uses a separate and unique electronic control system. See *FUNCTIONS OF THE 427R REFRIGERATOR ELECTRONIC CONTROL SYSTEM*.

▲ WARNING
TO AVOID ELECTRIC SHOCK, POWER TO THE UNIT MUST BE DISCONNECTED WHENEVER ACCESSING AND/OR REMOVING COMPONENTS POWERED BY ELECTRICITY OR COMPONENTS NEAR OTHER ELECTRICAL COMPONENTS.
EVEN WHEN UNIT IS SWITCHED OFF, 115 VOLTS AC IS STILL PRESENT AT THE CONTROL BOARD.

Sense and Display Average Compartment Temperatures

The temperature signal from the thermistor in each compartment is monitored by the microprocessor, and displayed on the LED's in the control panel assembly. Though the compartment air temperature may fluctuate slightly, the LED's in the control panel will display the average temperature. (See Figure 3-10)

NOTE: The temperature range in a wine storage compartment is 38°F / 3°C to 65°F / 18°C. The temperature range in the refrigerator drawer section of a 427R is 34°F / 1°C to 45°F / 7°C.

NOTE: If a compartment temperature should ever exceed either the high offset or low offset (for example: when a door is left open), the temperature displayed at the control panel will change by 1° per minute.

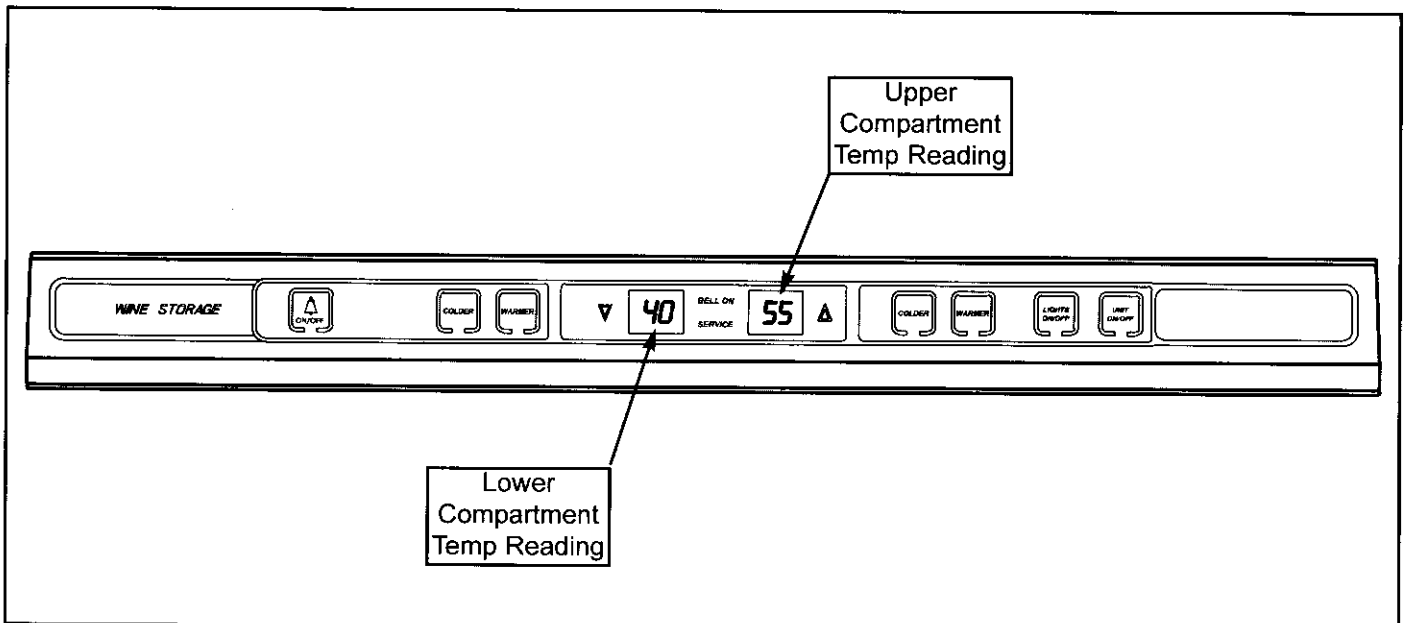

Figure 3-10. Temperature Display (Shown in degrees Fahrenheit)

Supply Power to the Lighting System

A continuous 115 Volts AC is supplied to the lighting system, so it is possible to energize the lights to stay "ON" 100% of the time, even if the door is closed. (See Wine Storage Lighting System ON/OFF). The lighting system can also be disabled for the observance of certain religious days. (See Sabbath Mode) The illustration below shows normal operation, with 115 Volts AC supplied to the lighting system. (See Figure 3-11)

▲ WARNING

ELECTRIC SHOCK HAZARD. 115 VOLTS IS STILL PRESENT AT THE CONTROL BOARD AND LIGHT SWITCH WHEN LIGHTS ARE DISABLED.

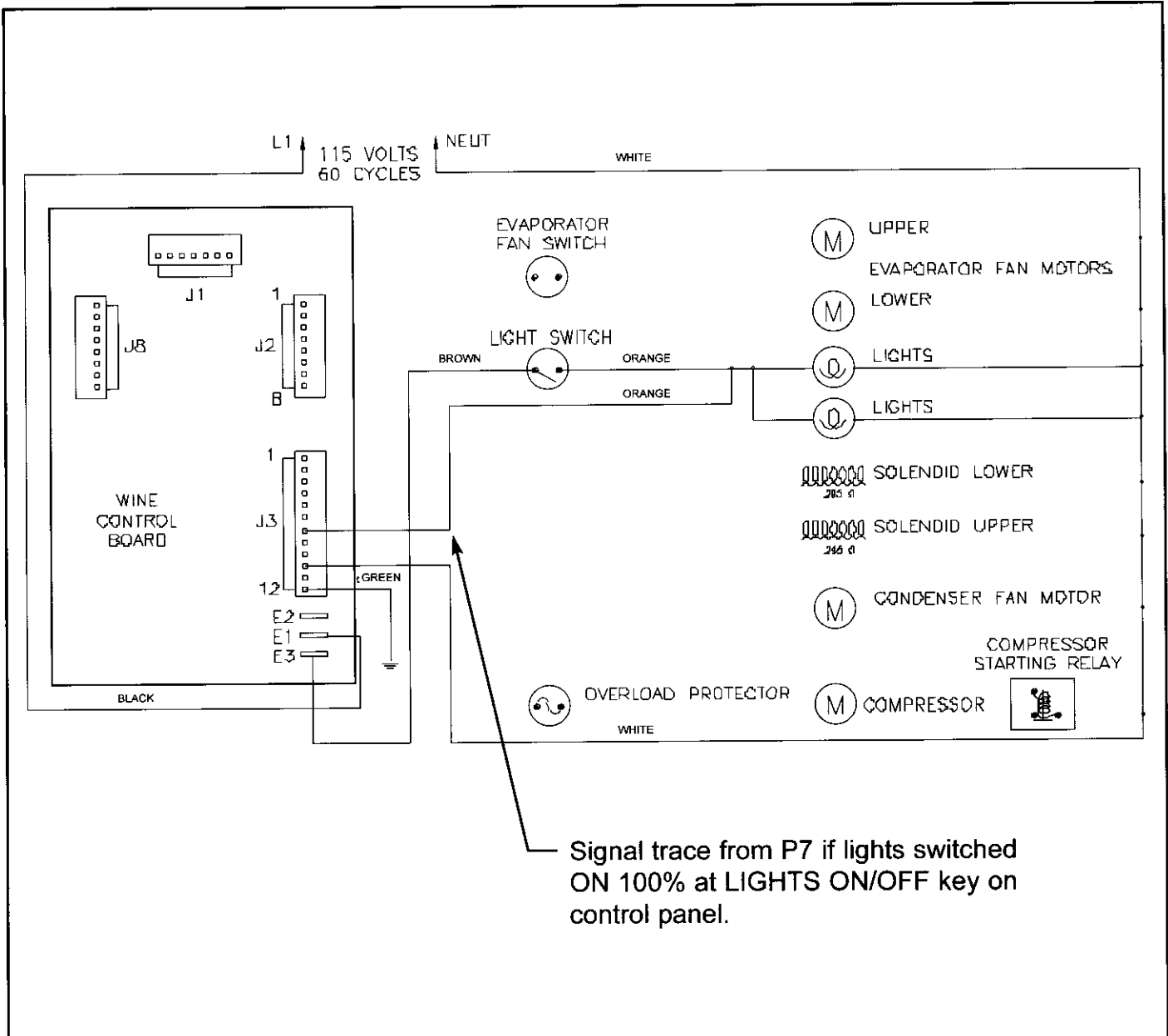

Figure 3-11. Lighting System Signal Trace

Supply Power to the Evaporator Fans

Prior to serial #1944319, a continuous 115 Volts AC is supplied to the evaporator fan switch, so the evaporator fans run 100% unless the door is open, or the unit is in Showroom Mode. (See Figure 3-12)

Starting with serial #1944319, a second fan switch was added to 400 series units. Both fan switches are in parallel circuits with the corresponding refrigerant valve solenoid. When a solenoid is energized, the corresponding evaporator fan switch is energized, cycling the fans on and off with the solenoids. The evaporator fans will also be switched off when the door is open, or the unit is in Showroom Mode. (See Figure 3-13)

NOTE: Prior to serial #1517005, the evaporator fans will run 100%, even while unit is in Showroom Mode.

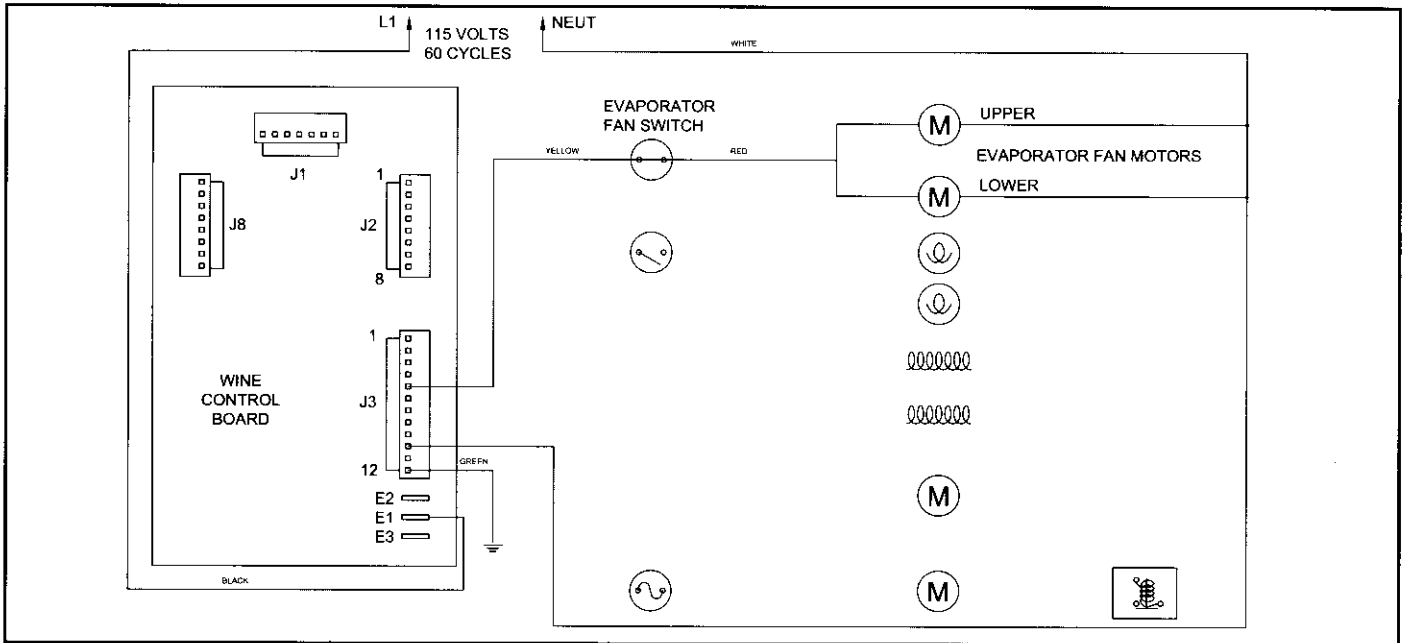

Figure 3-12. Evaporator Fan Power Signal Trace, Prior to Serial #1944319

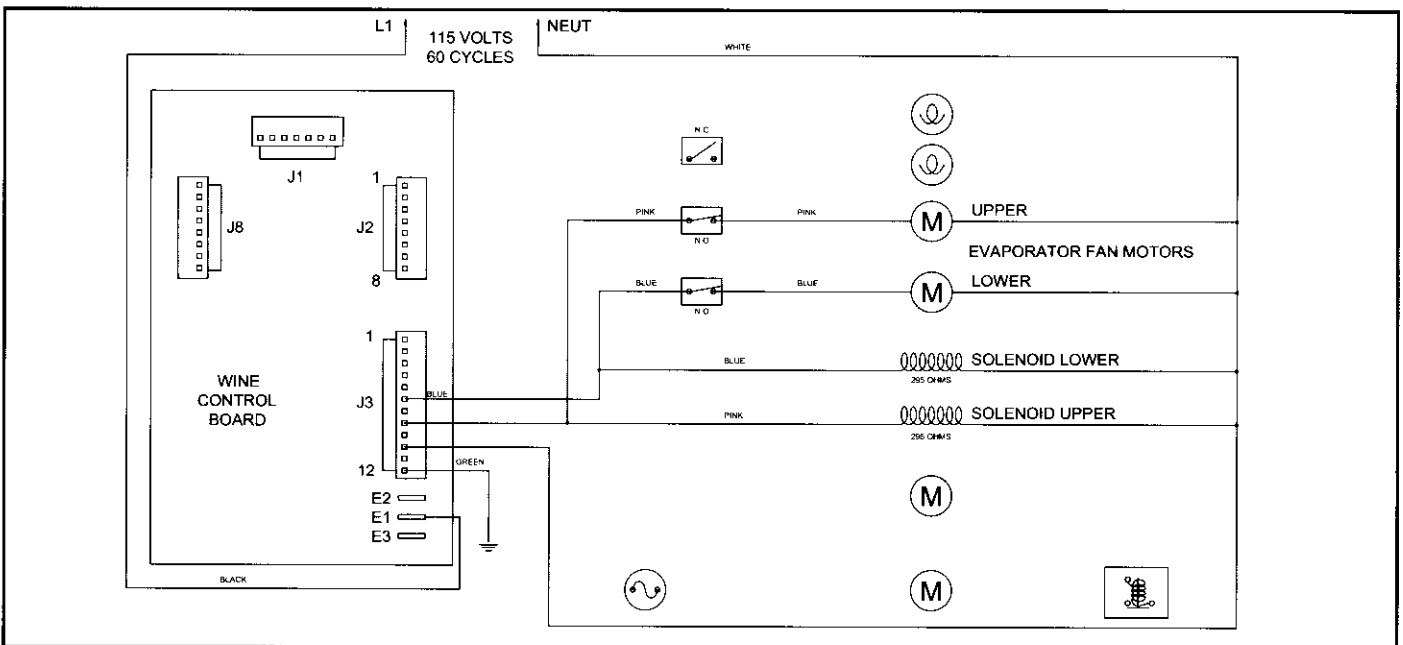

Figure 3-13. Evaporator Fan Power Signal Trace, Starting with Serial #1944319

Senses Evaporator and Compartment Temperatures to Regulate Refrigerant Valve Activity and Control Compressor and Condenser Fan Cycling (Prior to Serial #1944319)

The wine storage electronic control senses evaporator and compartment temperatures via thermistors, one on each evaporator and one in each compartment. The "cut-in" is governed by the temperature of the evaporators and the "cut-out" is governed by the temperature in each compartment. The cut-in temperature and cut-out temperature are based on the compartment set-point. If a compartment calls for cooling (evaporator at cut-in temperature), the corresponding refrigerant solenoid valve is energized/opened, allowing refrigerant to flow to the evaporator, but the electronic control will allow power to only one valve solenoid at a time. When one refrigerant solenoid valve is energized/open, the other is de-energized/closed. If neither compartment is calling for cooling, the compressor and condenser fan are switched off. The illustration below shows normal operation with the upper compartment calling for cooling. (See Figure 3-14)

NOTE: Prior to serial #1944319, the condenser fan in the model 427R runs 100%. (Not shown in this illustration.)

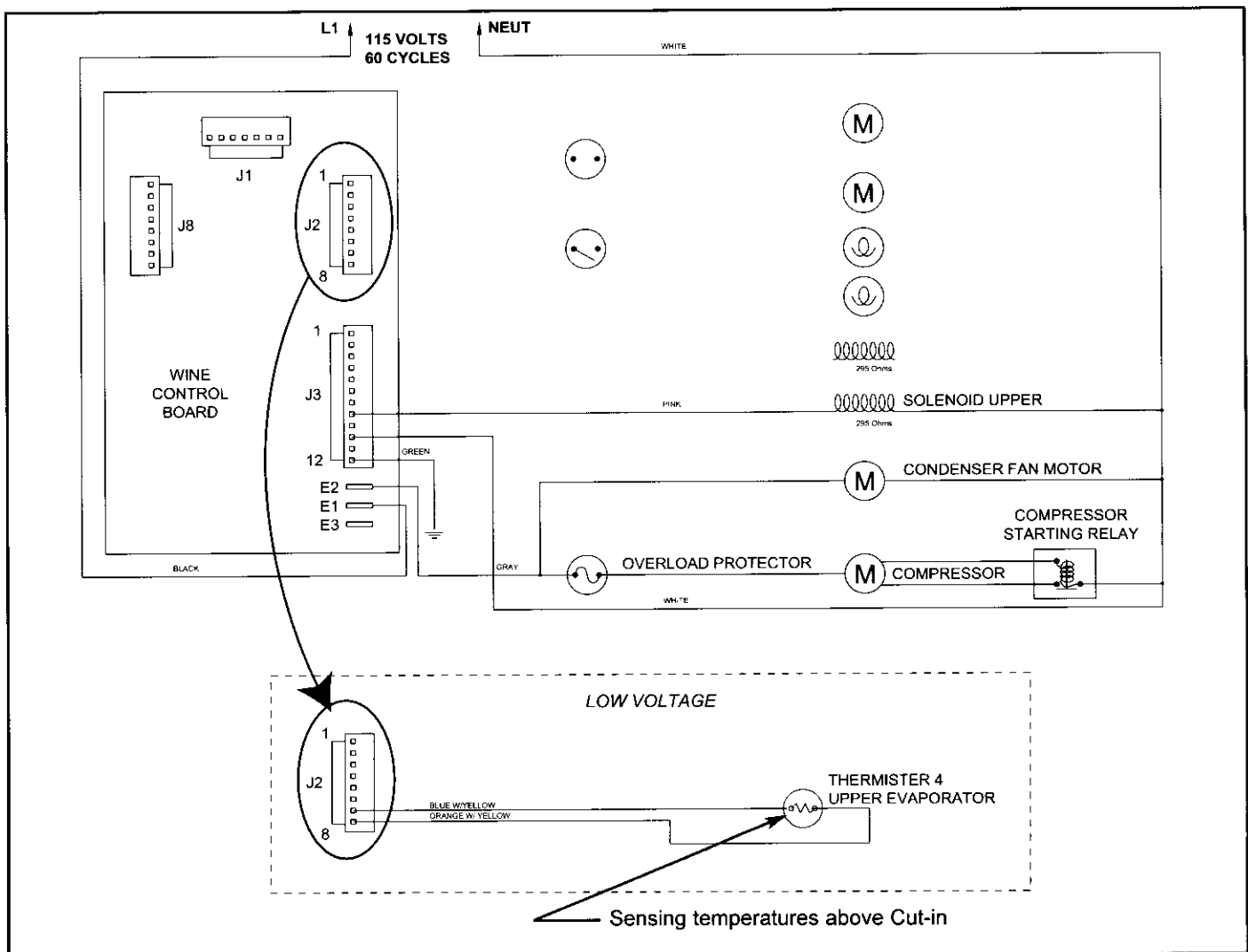

Figure 3-14. Compressor, Condenser Fan & Refrigerant Valve Solenoid Signal Trace, Upper Wine Storage Compartment Calling for Cooling (Prior to Serial #1944319)

Senses Evaporator and Compartment Temperatures to Regulate Refrigerant Valve and Evaporator Fan Motor Activity and Control Compressor and Condenser Fan Cycling (Starting with Serial #1944319)

The wine storage electronic control senses evaporator and compartment temperatures via thermistors, one on each evaporator and one in each compartment. The "cut-in" is governed by the temperature of the evaporators and the "cut-out" is governed by the temperature in each compartment. The cut-in temperature and cut-out temperature are based on the compartment set-point. If a compartment calls for cooling (evaporator at cut-in temperature), the corresponding refrigerant solenoid valve is energized/opened, allowing refrigerant to flow to the evaporator, but the electronic control will allow power to only one valve solenoid at a time. When one refrigerant solenoid valve is energized/open, the other is de-energized/closed.

Starting with serial #1944319, a second fan switch was added to 400 series units. Both fan switches are in parallel circuits with the corresponding refrigerant valve solenoid. When a solenoid is energized, the corresponding evaporator fan switch is energized, cycling the fans on and off with the solenoids.

If neither compartment is calling for cooling, the compressor and condenser fan are switched off. The illustration below shows normal operation with the upper compartment calling for cooling. (See Figure 3-15)

NOTE: Starting with serial #1944319, a condenser fan relay was added to the model 427R, so that the the condenser fan will only run when one or both of the compressors are energized. (Not shown in this illustration.)

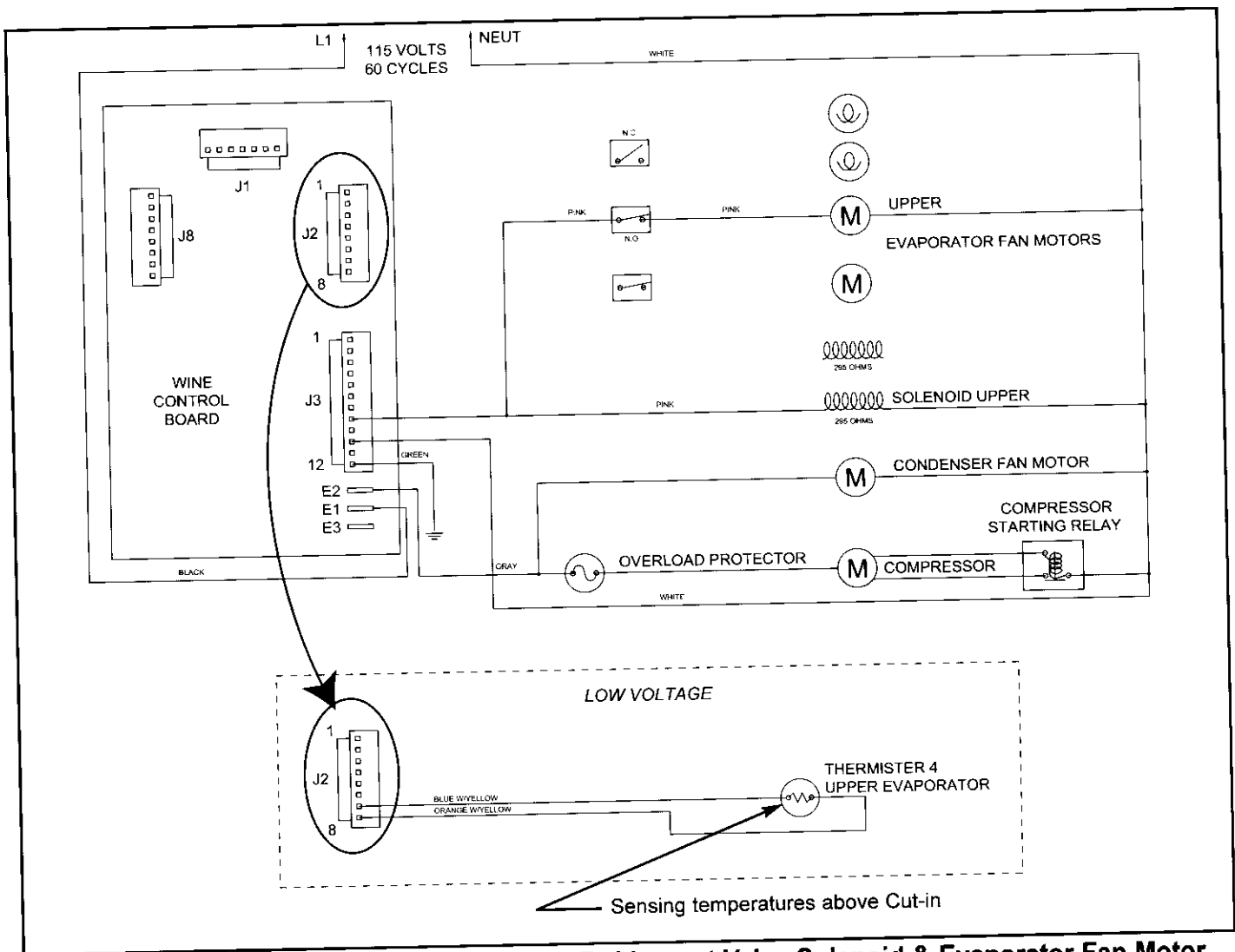

Figure 3-15. Compressor, Condenser Fan, Refrigerant Valve Solenoid & Evaporator Fan Motor Signal Trace, Upper Wine Storage Compartment Calling for Cooling (Starting with Serial #1944319)

Monitor and Control Wine Storage Off-cycle Defrost

The temperature signals from the compartment thermistor and evaporator thermistor are monitored by the electronic control. Since the evaporator thermistor governs the cut-in, the evaporator will fully defrost, rising above cut-in temperature, before calling for cooling. (See Figure 3-16)

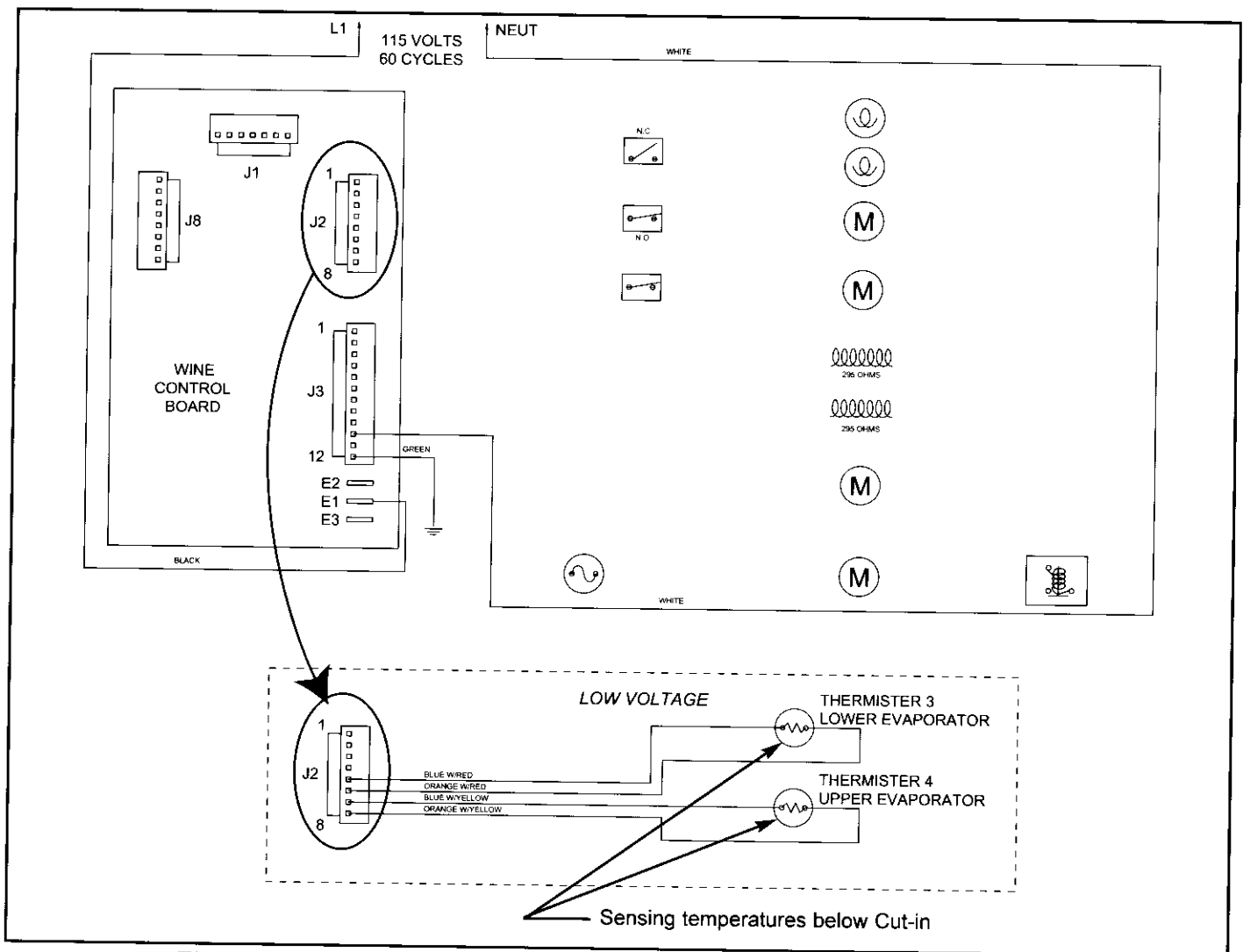

Figure 3-16. Temperature Sensed at Evaporators is Below Cut-in, No Cooling is Called For - Evaporators Defrost

UNIQUE WINE STORAGE ELECTRONIC CONTROL INPUT OPERATIONS:

This section illustrates unique wine storage electronic control input operations performed at the control panel, that you would not expect a customer to perform every day. This section explains the Temperature Units Selection Mode, Sabbath Mode and Showroom Mode.

NOTE: The refrigerator section of the model 427R uses a separate and unique electronic control system. See 427R REFRIGERATOR SECTION, UNIQUE ELECTRONIC CONTROL INPUT OPERATIONS.

Temperature Units Selection Mode (Selecting °Fahrenheit or °Celsius Display)

The wine storage electronic control is initially set to display temperature in Fahrenheit (°F) units of measure. But, the temperature units displayed can be converted from °F to °C (Celsius), and/or back again. This operation is called Temperature Units Selection.

NOTE: Temperature Units Selection must be performed within the first minute after switching the wine storage appliance ON.

To convert the temperature units of measure from a Fahrenheit (°F) reading to a Celsius (°C) reading, press and hold the alarm bell key and the UNIT ON/OFF key simultaneously for five seconds. (See Figure 3-17) You are now in Temperature Units Selection Mode. A temperature is now shown in the left display window, and the right display window indicates the units of measure as °F or °C. In this case, a temperature will be displayed in Celsius (°C) units of measure. (See Figure 3-18)

NOTE: Do not press and hold the UNIT ON/OFF key first, as this will simply switch the unit OFF.

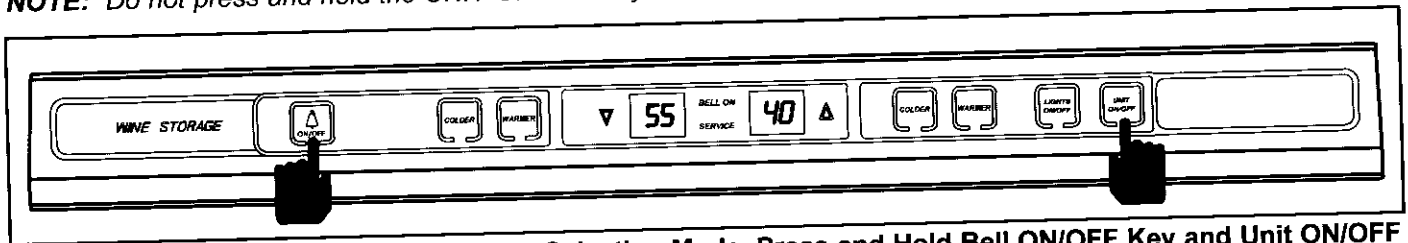

Figure 3-17. Initiating Temperature Units Selection Mode, Press and Hold Bell ON/OFF Key and Unit ON/OFF Key Simultaneously for Five Seconds

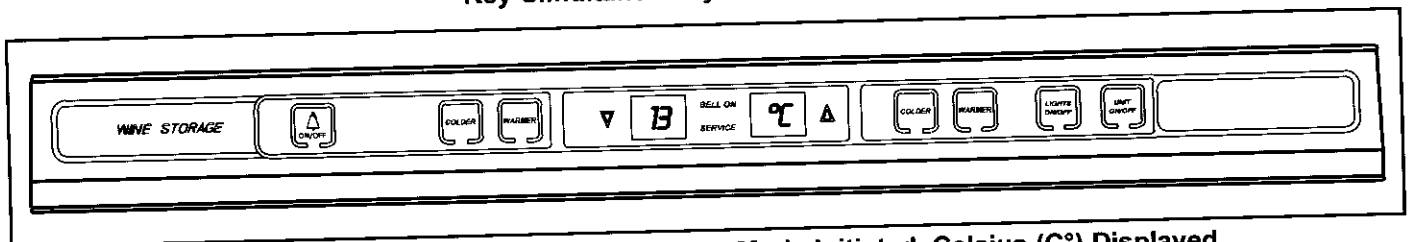

Figure 3-18. Temperature Units Selection Mode Initiated, Celsius (C°) Displayed

To convert back to °F from °C, repeat the steps of pressing and holding the alarm bell ON/OFF key and the UNIT ON/OFF key simultaneously, keeping in mind that you can toggle between °F and °C for one minute. (See Figure 3-19)

NOTE: The control will exit Temperature Units Selection Mode ten seconds after the last key stroke. To reinitiate Temperature Units Selection Mode, press the UNIT ON/OFF key to switch the unit OFF, then press it again to switch the unit back ON. Now, within one minute follow the steps above.

NOTE: Temperature Units Selection Mode must be initiated separately in the refrigerator section of model 427R.

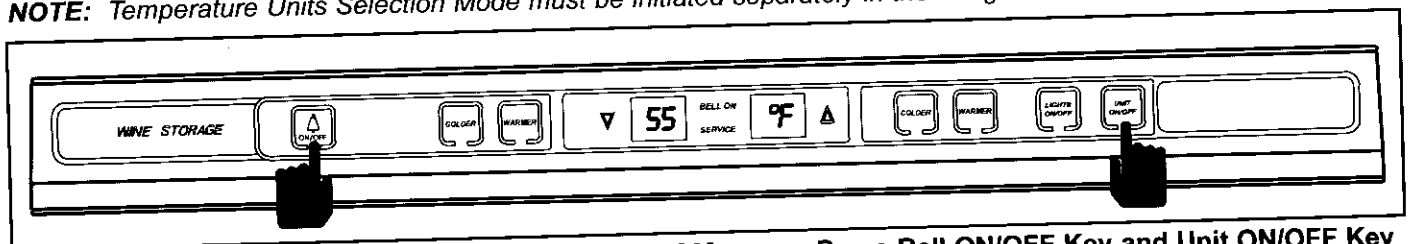

Figure 3-19. Toggle back to Fahrenheit (°F) Units of Measure, Press Bell ON/OFF Key and Unit ON/OFF Key Simultaneously

Sabbath Mode

A Sabbath Mode was incorporated into the wine storage electronic control system for the observance of certain religious days. Initiating Sabbath Mode disables the lighting circuit so that the lights will not function when the door is open or closed. Also while in Sabbath Mode, the LIGHTS ON/OFF key is disabled.

To initiate Sabbath Mode, the unit must be switched OFF. (See Figure 3-20) With the unit switched OFF, press and hold the UNIT ON/OFF key for ten seconds. (See Figure 3-21)

To return to normal lighting operation, press and release the UNIT ON/OFF key. (See Figure 3-22)

NOTE: Sabbath Mode must be initiated separately in the refrigerator section of model 427R.

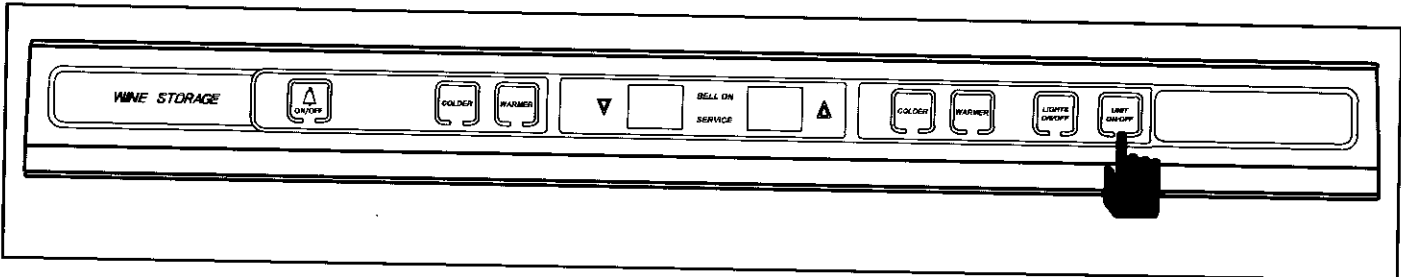

Figure 3-20. Switch Unit OFF First

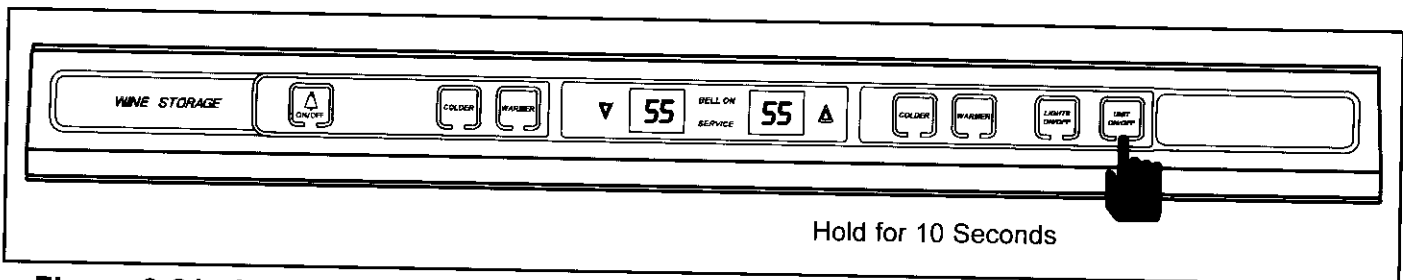

Figure 3-21. Initiate Sabbath Mode, Press and Hold UNIT ON/OFF Key for Ten Seconds

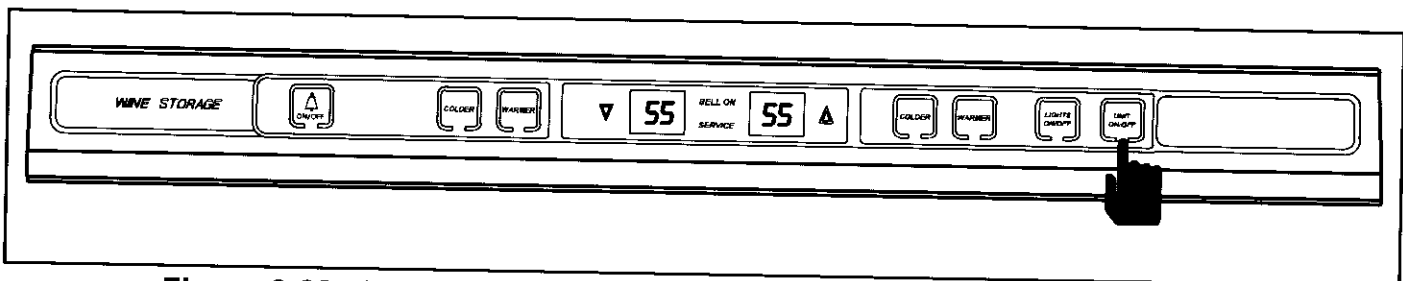

Figure 3-22. Exit Sabbath Mode, Press and Release UNIT ON/OFF Key

Showroom Mode

Showroom Mode was incorporated into the electronic control of the wine storage units to allow product distributors and dealers to display a 400 Series unit without actually having it cooling. To initiate Showroom Mode, the unit must be switched OFF. (See Figure 3-23) With the unit switched off, press and hold the upper compartment COLDER and WARMER keys and press the UNIT ON/OFF key, then release all three keys. (See Figure 3-24) The unit is now in Showroom Mode. All cooling functions are disabled, but the lighting system remains energized. This allows the lights to be switched ON and OFF, either by the door light switch or the LIGHTS ON/OFF key on the control panel. This also allows the LED's for the temperature displays to illuminate, the BELL ON annunciator can be illuminated by pressing the bell key, the COLDER and WARMER keys will function to simulate adjusting the set-point, and the unit can seemingly be switched ON and OFF by pressing the UNIT ON/OFF key. (See Figure 3-25)

To exit Showroom Mode, press the UNIT ON/OFF key to switch all functions OFF. (See Figure 3-23) With all functions switched off, press and hold the upper compartment COLDER and WARMER keys and press the UNIT ON/OFF key, then release all three keys. (See Figure 3-24) All unit functions are now restored. This can be verified by checked for evaporator fan operation, and/or compressor operation.

NOTE: The evaporator fan in units prior to serial #1517005, will run 100%, even while unit is in Showroom Mode.

NOTE: On the model 427R, the condenser fan will run 100% of the time after the unit is energized, including while in Showroom Mode.

NOTE: Showroom Mode must be initiated separately in the refrigerator section of model 427R.

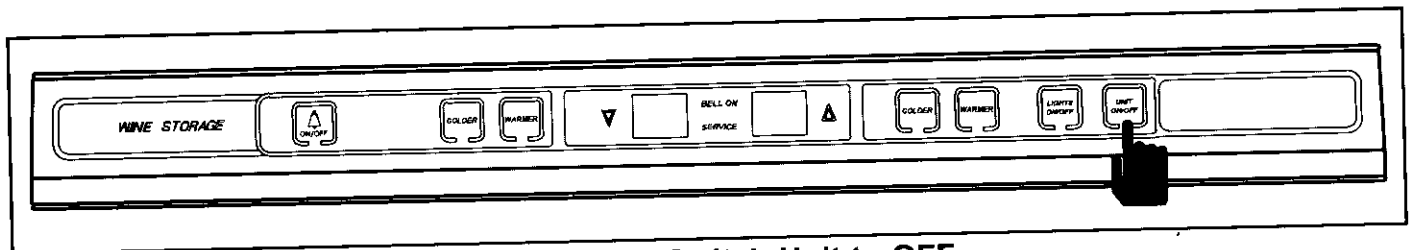

Figure 3-23. Switch Unit to OFF

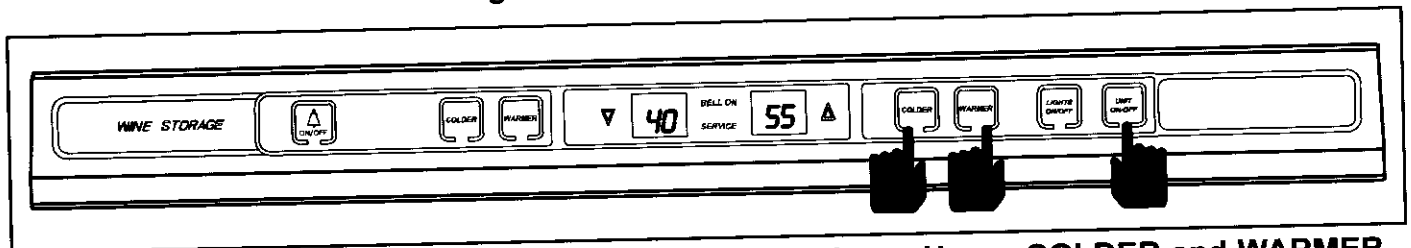

Figure 3-24. Initiate Showroom Mode, Press and Release Upper COLDER and WARMER Keys and UNIT ON/OFF Key (Same for Exiting Showroom Mode)

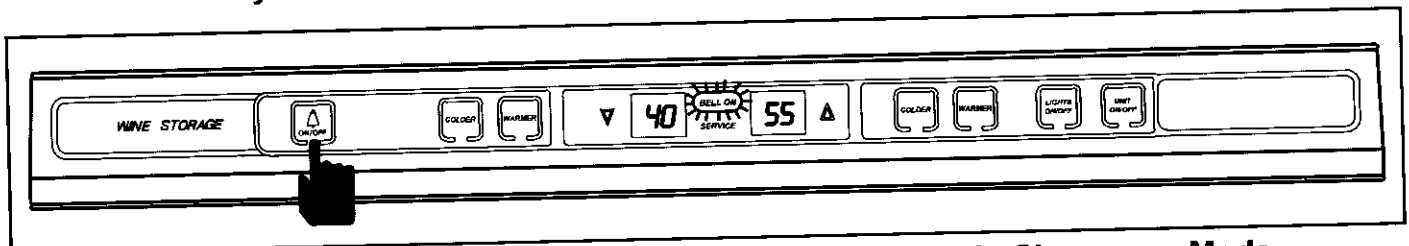

Figure 3-25. Illuminating BELL ON Annunciator while in Showroom Mode

WINE STORAGE TEMPERATURE ALARM FEATURE AND POSSIBLE ERROR INDICATORS:

All wine storage units are equipped with an audio-visual temperature alarm feature. Low voltage wiring provisions on all 400 Series units also makes it possible to tie the temperature alarm feature into a home security alarm system. This section explains the temperature alarm feature and the audio and/or visual error indicators that may alert a customer of a malfunction.

NOTE: If the temperature alarm feature is tied into a home security system, the connections are made using the security system's logic. If problems occur between the wine storage unit and the security system, then a home security system technician should be contacted.

NOTE: The refrigerator section of the model 427R uses a separate and unique electronic control system. See 427R REFRIGERATOR SECTION, POSSIBLE ERROR INDICATORS.

Warm Temperature Alarm

A warm temperature alarm occurs if either wine storage compartment temperature remains excessively warm for too long, causing several consecutive maximum run-time cycles. During a warm temperature alarm, you will notice warm temperature readings displayed at the control panel and the SERVICE annunciator will flash. (See Figure 3-26) A warm temperature alarm will also cut power to the compressor, condenser fan, both refrigerant valves, the lights and the evaporator fans via the relays on the control board. If the BELL ON feature has been enabled by pressing the bell key on the control panel, the BELL ON annunciator will also flash, and the audible alarm will beep. (See Figure 3-27)

NOTE: To clear the warm temperature alarm, press the UNIT ON/OFF key to switch the unit Off, then press it again to switch the unit back ON. (See Figure 3-28)

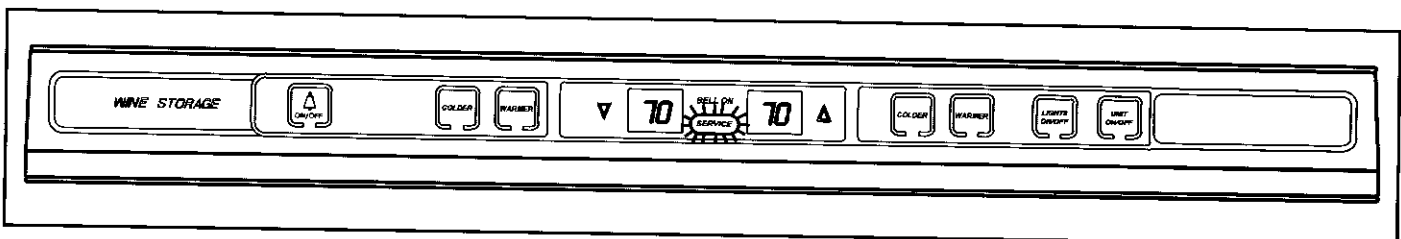

Figure 3-26. Warm Temperature Alarm, "SERVICE" Flashing

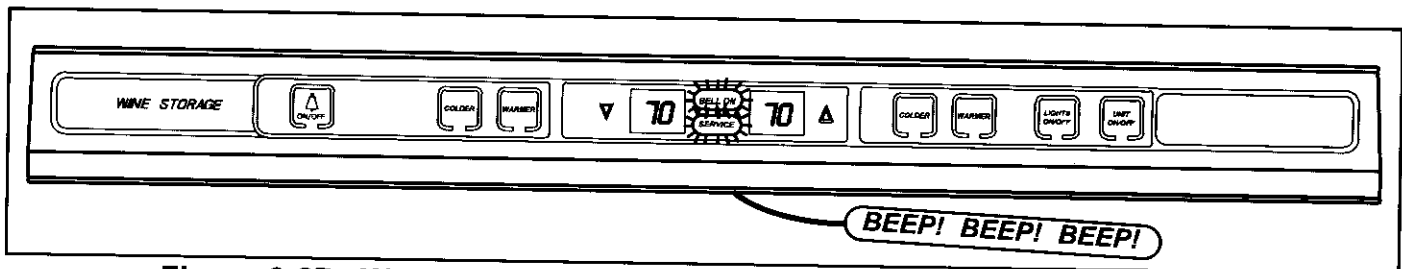

Figure 3-27. Warm Temperature Alarm with BELL ON Feature Enabled, "SERVICE" and "BELL ON" Flashing with Audible Alarm Beeping

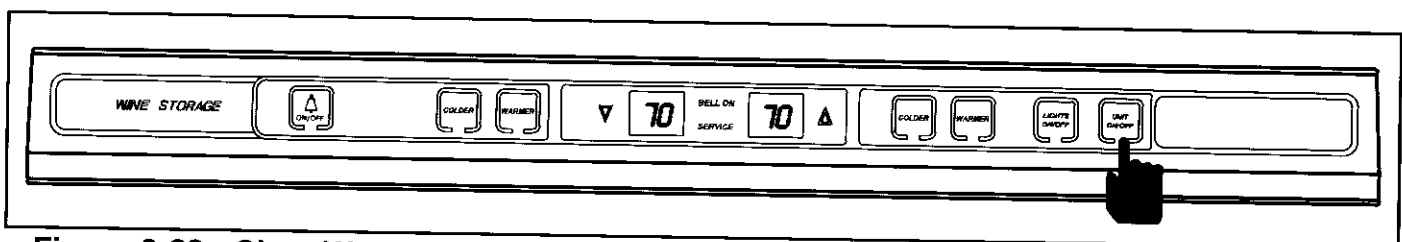

Figure 3-28. Clear Warm Temperature Alarm, Press UNIT ON/OFF Key to Off, Then ON.

Cold Temperature Alarm

A cold temperature alarm occurs if either wine storage compartment goes below 38°F / 3°C and remains below 38°F / 3°C for too long. During a cold temperature alarm, you may notice cold temperature readings displayed at the control panel (if recently initiated) and the SERVICE annunciator will flash. (See Figure 3-29) A cold temperature alarm will also cut power to the compressor, condenser fan, both refrigerant valves, the lights and the evaporator fans via the relays on the control board. If the BELL ON feature has been enabled by pressing the bell key on the control panel, the BELL ON annunciator will also flash, and the audible alarm will beep. (See Figure 3-30)

NOTE: To clear the cold temperature alarm, press the UNIT ON/OFF key to switch the unit Off, then press it again to switch the unit back ON. (See Figure 3-31)

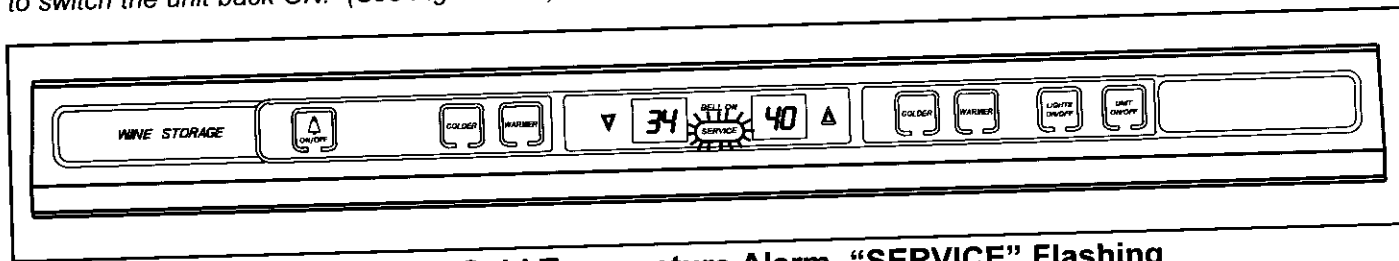

Figure 3-29. Cold Temperature Alarm, "SERVICE" Flashing

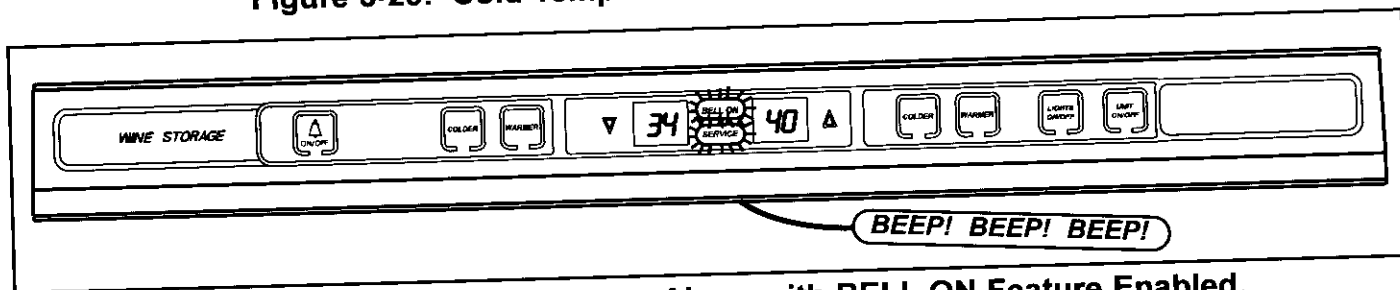

Figure 3-30. Cold Temperature Alarm with BELL ON Feature Enabled, "SERVICE" and "BELL ON" Flashing with Audible Alarm Beeping

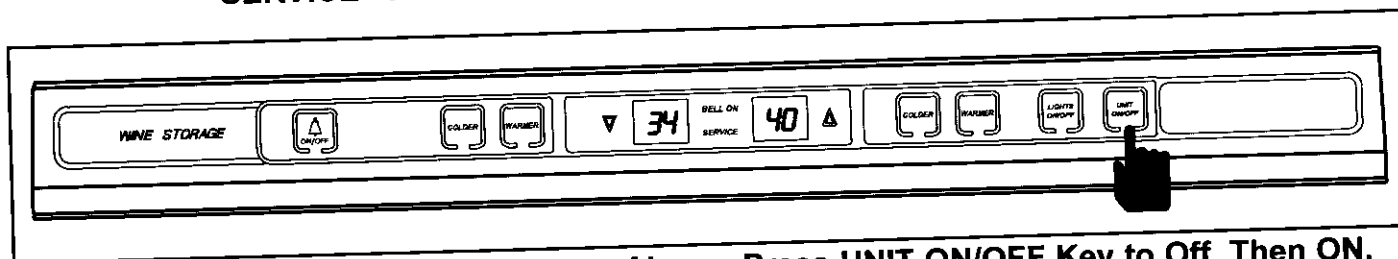

Figure 3-31. Clear Cold Temperature Alarm, Press UNIT ON/OFF Key to Off, Then ON.

Thermistor Malfunction Error Indicators

A wine storage thermistor fault, such as a short or open condition, will be displayed at the control panel. If there is a problem with either of the compartment thermistors, the temperature display window for that compartment will be flashing the letters "EE" and the SERVICE annunciator will be flashing too. A compartment thermistor fault will also cut power to the compressor, condenser fan, both refrigerant valves, the lights and the evaporator fans via the relays on the control board. If the BELL ON feature has been enabled, the BELL ON annunciator will also flash, and the audible alarm will beep. (See Figures 3-32 to 3-35)

If there is a problem with either of the evaporator thermistors, the SERVICE annunciator will flash. An evaporator thermistor fault will also cut power to the compressor, condenser fan, both refrigerant valves, the lights and the evaporator fans via the relays on the control board. If the BELL ON feature has been enabled, the BELL ON annunciator will also flash, and the audible alarm will beep. (See Figures 3-36 and 3-37)

NOTE: Correcting/repairing the thermistor problem will clear the Thermistor Malfunction Error Indicator.

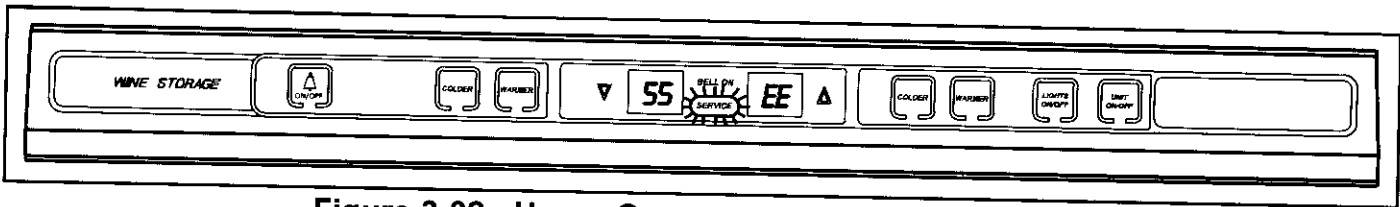

Figure 3-32. Upper Compartment Thermistor Fault

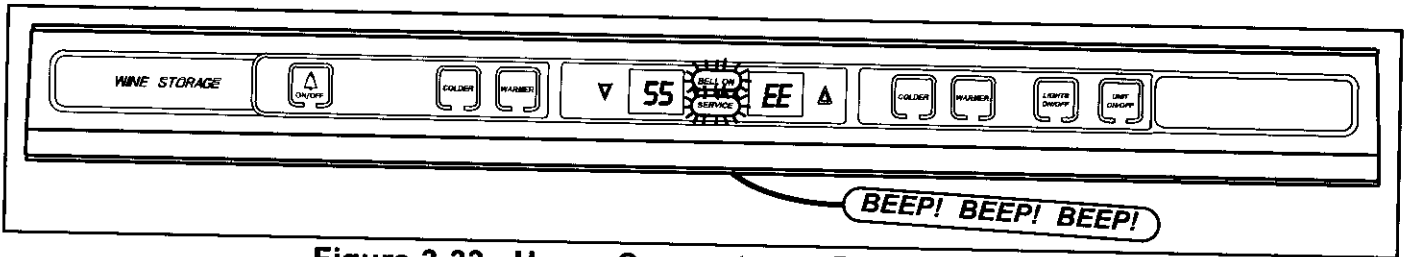

Figure 3-33. Upper Compartment Thermistor Fault with BELL ON Feature Enabled and Flashing

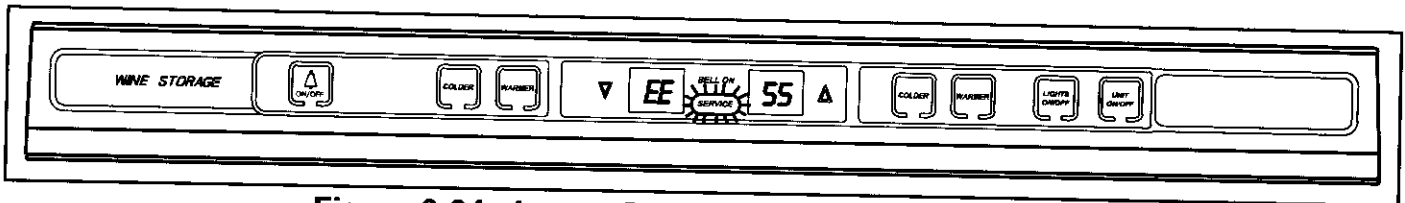

Figure 3-34. Lower Compartment Thermistor Fault

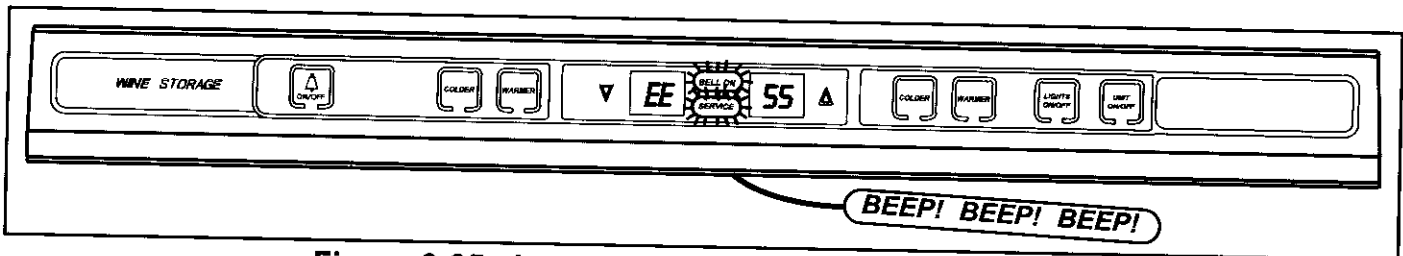

Figure 3-35. Lower Compartment Thermistor Fault with BELL ON Feature Enabled and Flashing

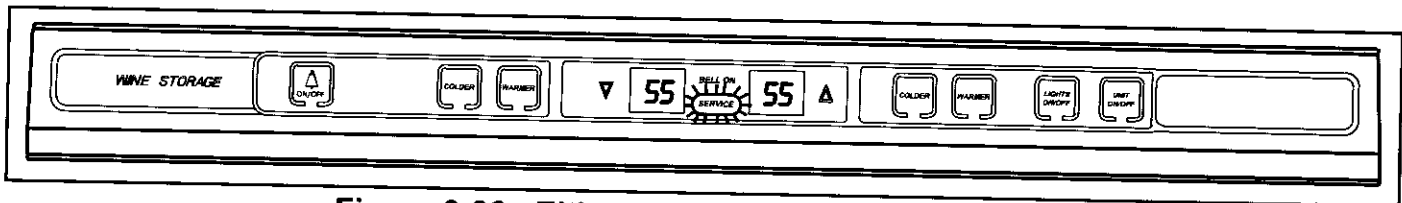

Figure 3-36. Either Evaporator Thermistor Fault

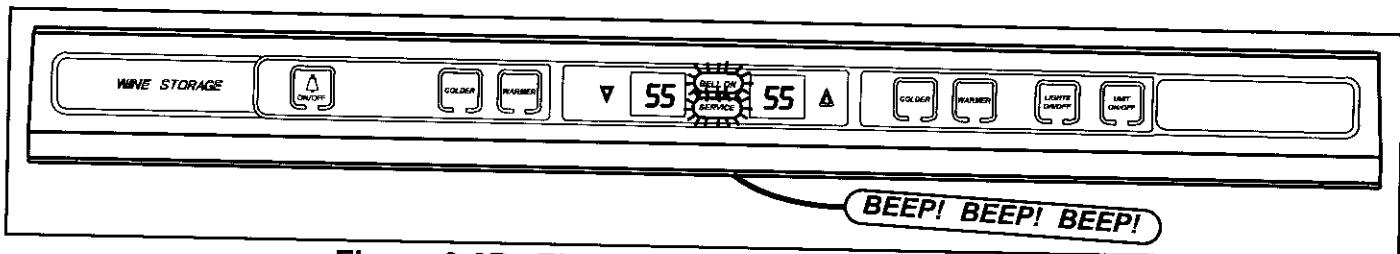

Figure 3-37. Either Evaporator Thermistor Fault with BELL ON Feature Enabled and Flashing

WINE STORAGE DIAGNOSTIC MODE:

The Diagnostic Mode was incorporated into the wine storage electronic control system to assist in diagnosing problems in a wine storage unit. When in Diagnostic Mode, the real-time thermistor temperatures are shown in the left display window of the control panel, without off-set adjustments. The right display window indicates the location of the thermistor being read.

NOTE: The refrigerator section of the model 427R uses a separate and unique electronic control system. See 427R REFRIGERATOR SECTION, DIAGNOSTIC MODE.

To initiate Diagnostic Mode, the unit must be ON. Now, press and hold either compartment COLDER key, and press the UNIT ON/OFF key, then release both keys. (See Figure 3-38)

NOTE: Pressing and holding both keys for ten seconds or more will activate Manual Valve Activation Mode, which lasts for five minutes. This will be explained next in this manual.

You are now in Diagnostic Mode. The SERVICE annunciator is illuminated and a temperature is shown in the left display window, while the right display window indicates the location of the thermistor being read. Since the first thermistor location is the Upper Evaporator, "UE" is displayed in the right window. (See Figure 3-38)

Pressing the COLDER key at this time will toggle the reading to the next thermistor location and "LE" will be displayed in the right window, indicating Lower Evaporator temperature. (See Figure 3-39)

Again press the COLDER key to toggle to the next reading which is "UP" for UPper compartment temperature. (See Figure 3-40)

The fourth key stroke of the COLDER key will toggle to "LO" indicating the LOwer compartment temperature. (See figure 3-41)

NOTE: Diagnostic Mode will end ten seconds after the last key stroke. To observe an individual location temperature reading for more than ten seconds, press and hold the UNIT ON/OFF key while in Diagnostic Mode. (See Figure 3-42)

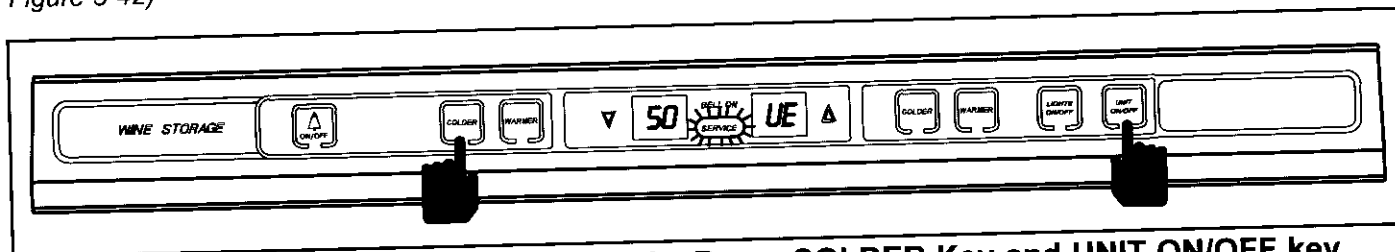

Figure 3-38. Initiating Diagnostic Mode, Press COLDER Key and UNIT ON/OFF key. First Reading is Upper Evaporator

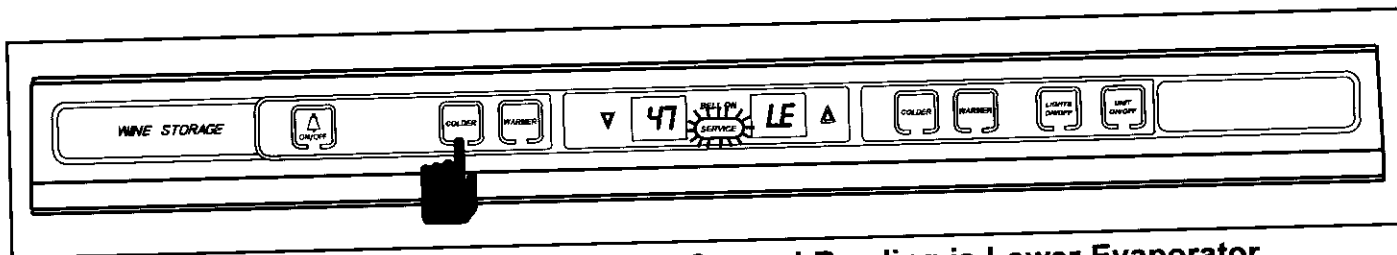

Figure 3-39. Press COLDER Key. Second Reading is Lower Evaporator

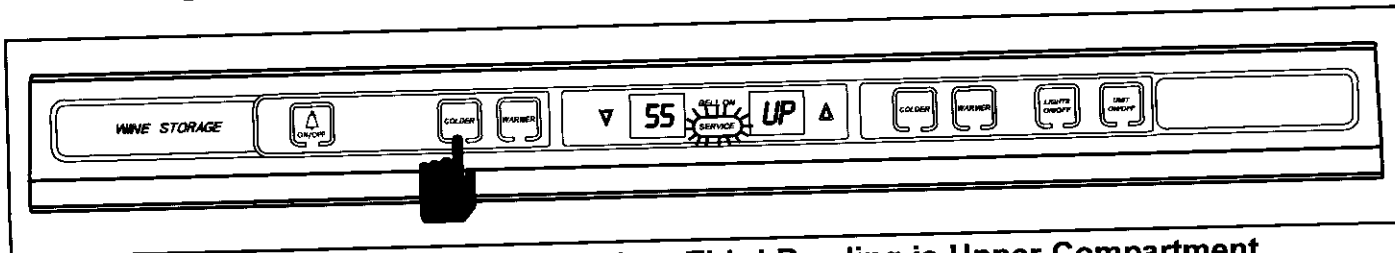

Figure 3-40. Press COLDER Key. Third Reading is Upper Compartment

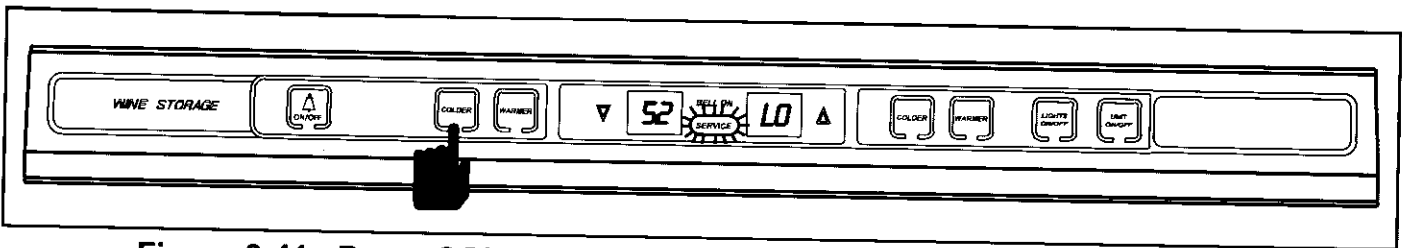

Figure 3-41. Press COLDER Key. Fourth Reading is Lower Compartment

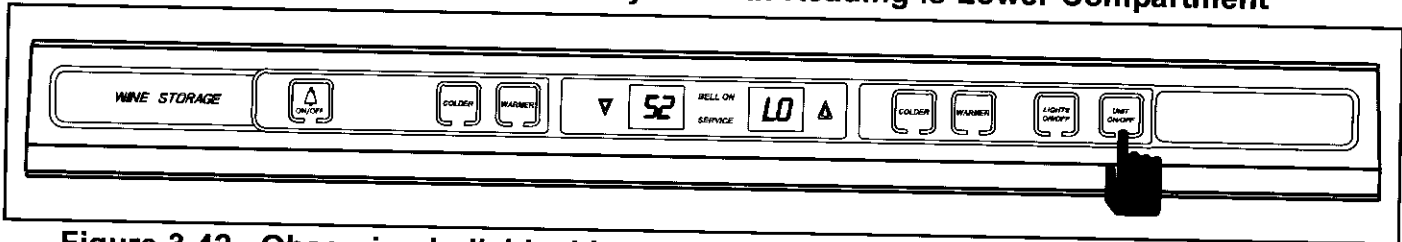

Figure 3-42. Observing Individual Location Temperature Reading for More than Ten Seconds, Press and Hold UNIT ON/OFF Key While in Diagnostic Mode

MANUAL WINE STORAGE REFRIGERANT VALVE ACTIVATION MODE:

To further assist with diagnostics in a wine storage unit, Refrigerant Valve Activation Mode was incorporated into the electronic control system. Refrigerant Valve Activation Mode allows you to energize either of the two valve solenoids for five minutes and observe the evaporator temperatures in the corresponding compartment. When in Refrigerant Valve Activation Mode, the real-time thermistor temperatures are shown in the left display window of the control panel, without off-set adjustments. The right display window will indicate which evaporator temperature you are observing.

To initiate Refrigerant Valve Activation Mode, the unit must be ON. Now, press and hold the desired compartment COLDER key, and the UNIT ON/OFF key for ten seconds (See Figure 3-43). You are now in Refrigerant Valve Activation Mode. The SERVICE annunciator is illuminated and you will now see the corresponding evaporator temperature in the left display window, and the right display window indicates which evaporator temperature you're observing, in the example below, we chose to observe the lower evaporator temperatures. (See Figure 3-43)

NOTE: It is recommended to press either COLDER key while in Manual Valve Activation Mode, in order to toggle to the other evaporator temperature reading to verify that the corresponding valve is not open.

NOTE: Refrigerant Valve Activation Mode will end after five minutes. To exit before the full five minutes, press the UNIT ON/OFF key to switch the unit OFF, then again to switch the unit back ON. (See Figure 3-44)

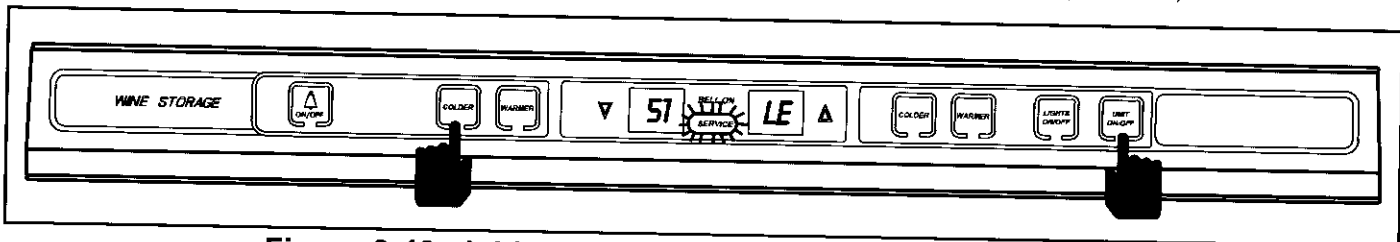
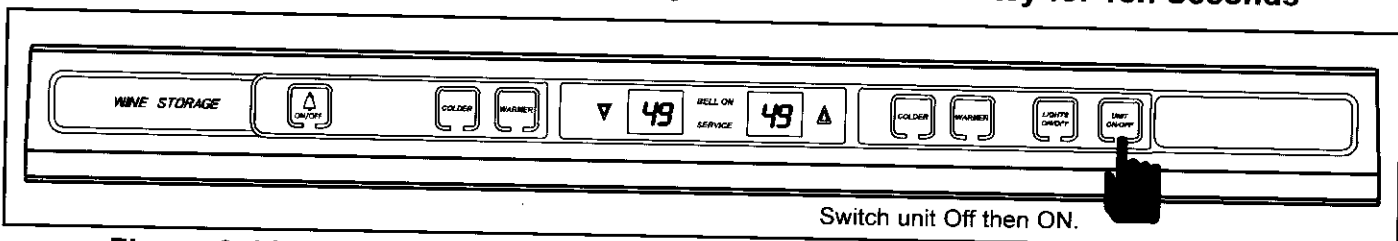

Figure 3-43. Initiating Refrigerant Valve Activation Mode, Press and Hold Desired COLDER Key and UNIT ON/OFF Key for Ten Seconds



Switch unit Off then ON.

Figure 3-44. Exit Refrigerant Valve Activation Mode Before Full Five Minutes, Press UNIT ON/OFF Key to OFF, Then again to ON

WINE STORAGE TEMPERATURE LOG RECALL MODE:

For service purposes, the wine storage electronic control is equipped with a temperature data storage system. This system logs/stores the average temperature of each wine compartment every four hours, along with any error indicator codes that may have occurred. This information is stored in memory so that even if there is a power interruption, the data is not lost. These four hour periods of data (referred to as "indexes") are logged a maximum of sixty-four times. What this means is that the average temperatures for the previous ten days and sixteen hours can be recalled and displayed at the control panel. (4 hour periods x 64 indexes = 10 days, 16 hours) Once sixty-four indexes are stored, each new index replaces the oldest index.

To initiate the Temperature Log Recall Mode, the unit must be running. Now, press and hold the desired compartment WARMER key, and press the UNIT ON/OFF key, then release both keys. (See Figure 3-45)

When initiated, a temperature will be displayed in one window and an index number will be displayed in the other, the order of which will depend on the WARMER key chosen. For the example, we chose the lower compartment WARMER key. (See Figure 3-46) The SERVICE annunciator and compartment indicator arrow will illuminate, and the first temperature displayed will be for the most recent four hour period, indicated by index number "1".

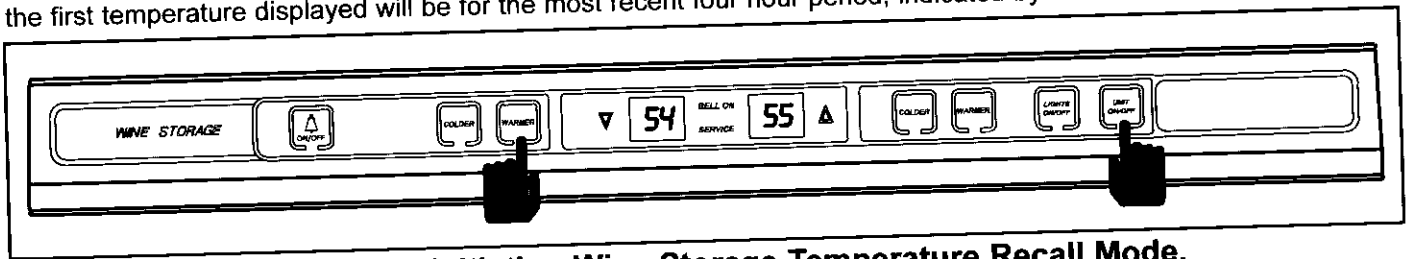

Figure 3-45. Initiating Wine Storage Temperature Recall Mode, Press WARMER Key and UNIT ON/OFF Key

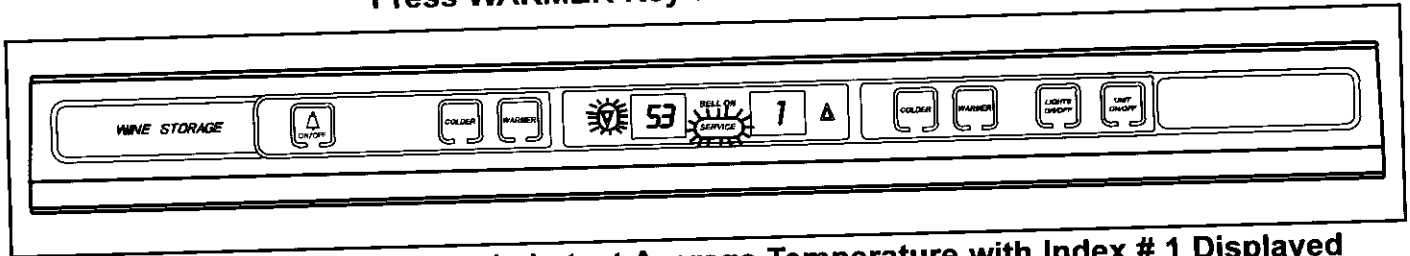

Figure 3-46. First Reading is Latest Average Temperature with Index # 1 Displayed

Pressing the WARMER key now will toggle to the second four hour temperature average period, indicated by index number "2". (See Figure 3-47) Toggling through the index can be done by pressing the WARMER key in multiple key strokes, a maximum of sixty-four times. (See Figure 3-48)

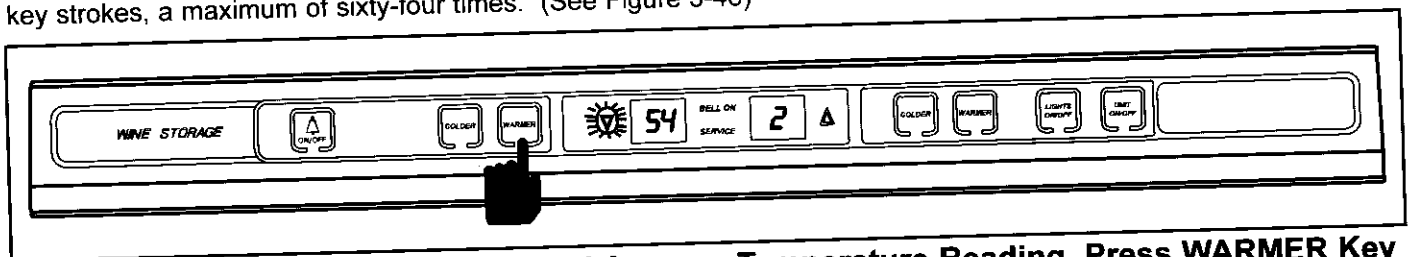

Figure 3-47. Toggle to 2nd Index and Average Temperature Reading, Press WARMER Key

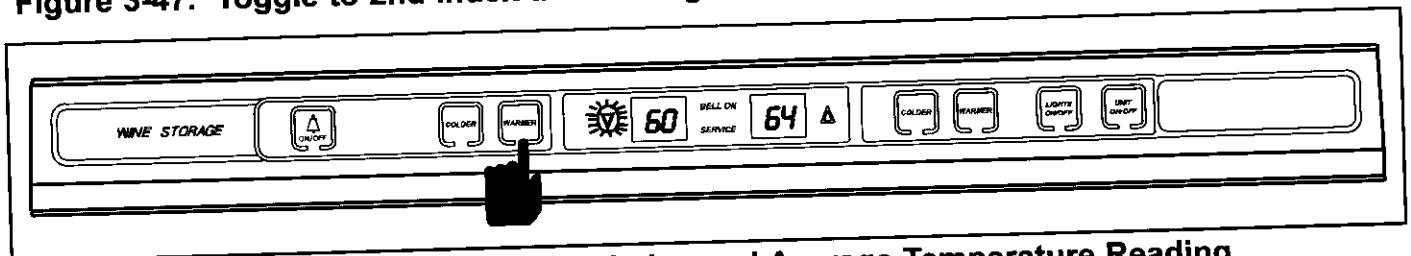

Figure 3-48. Toggle to 64th Index and Average Temperature Reading, Press WARMER Key in Multiple Key Strokes

You can also toggle backwards from index "64" to "1", or anywhere in the index sequence, by pressing the COLDER key in multiple key strokes. (See Figure 3-49)

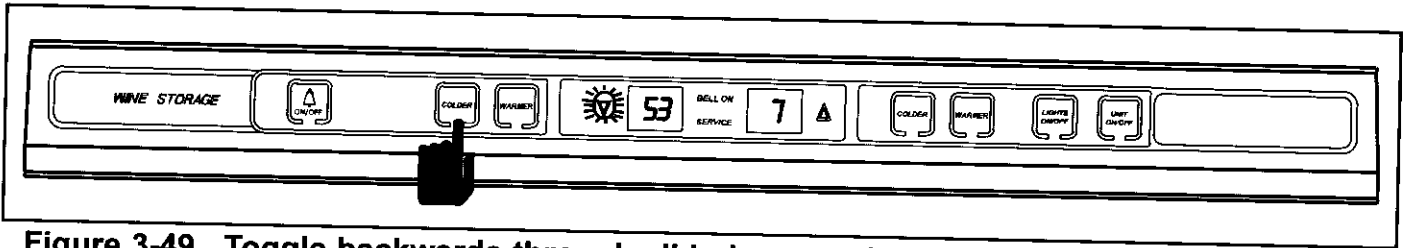

Figure 3-49. Toggle backwards through all Indexes and Average Temperature Readings, Press COLDER Key in Multiple Key Strokes

If the BELL ON annunciator illuminates during Temperature Log Recall Mode, this indicates that power to the electronic control was interrupted during the currently displayed four hour period. (See Figure 3-50)

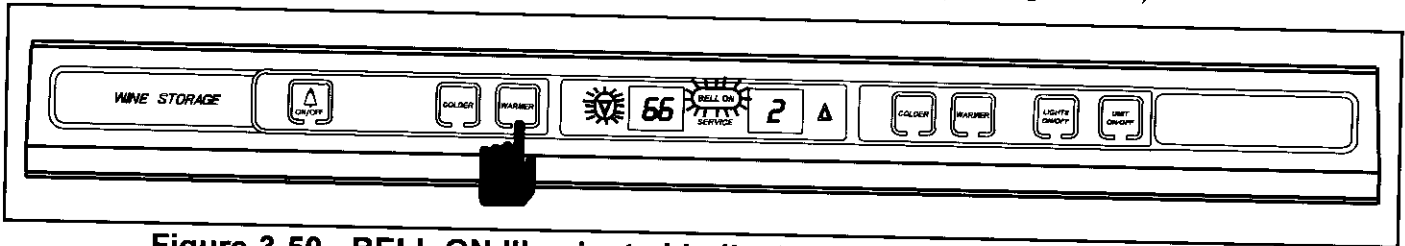

Figure 3-50. BELL ON Illuminated Indicates Power Failure / Interruption

If the SERVICE annunciator illuminates during Temperature Log Recall Mode, this indicates that the UNIT ON/OFF key was depressed, switching the unit OFF during the currently displayed four hour period. (See Figure 3-51)

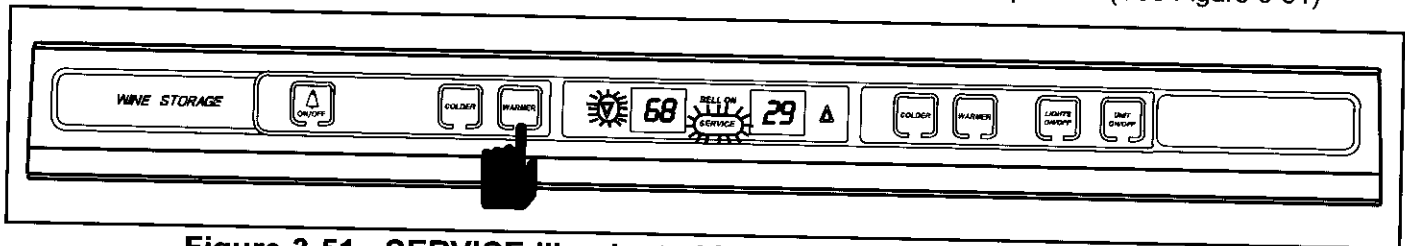

Figure 3-51. SERVICE Illuminated indicates Unit was Switched OFF

If double dashes (- -) are displayed instead of the temperature and index number, this indicates an electrical error on the electronic control board and that the board is bad. (See Figure 3-52)

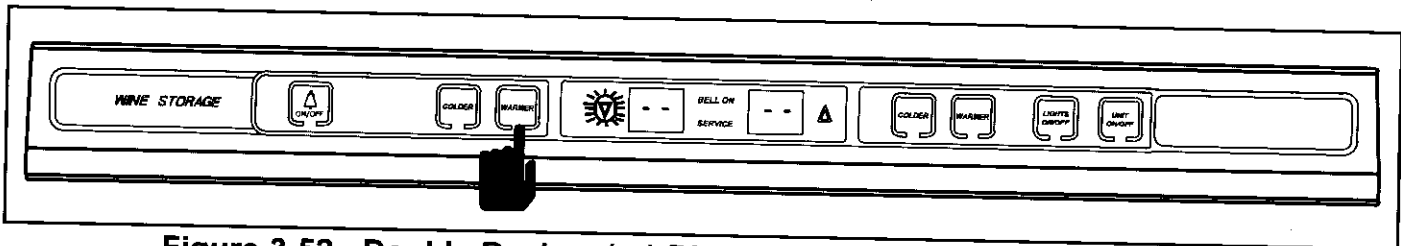

Figure 3-52. Double Dashes (- -) Displayed in Both Windows Indicates Electronic Control Board is Bad. Control Board must be Replaced.

NOTE: The electronic control will exit Temperature Log Recall Mode ten seconds after the last key stroke.



WINE STORAGE TEMPERATURE LOG INDEX CHART

| Index # | Previous Hours Time Frame | Index # | Previous Hours Time Frame | Index # | Previous Hours Time Frame |
|---------|---------------------------|---------|---------------------------|---------|-------------------------------|
| 1 | 4 Hours | 23 | 92 Hours | 45 | 180 Hours |
| 2 | 8 Hours | 24 | 96 Hours (4 Days) | 46 | 184 Hours |
| 3 | 12 Hours | 25 | 100 Hours | 47 | 188 Hours |
| 4 | 16 Hours | 26 | 104 Hours | 48 | 192 Hours (8 Days) |
| 5 | 20 Hours | 27 | 108 Hours | 49 | 196 Hours |
| 6 | 24 Hours (1 Day) | 28 | 112 Hours | 50 | 200 Hours |
| 7 | 28 Hours | 29 | 116 Hours | 51 | 204 Hours |
| 8 | 32 Hours | 30 | 120 Hours (5 Days) | 52 | 208 Hours |
| 9 | 36 Hours | 31 | 124 Hours | 53 | 212 Hours |
| 10 | 40 Hours | 32 | 128 Hours | 54 | 216 Hours (9 Days) |
| 11 | 44 Hours | 33 | 132 Hours | 55 | 220 Hours |
| 12 | 48 Hours (2 Days) | 34 | 136 Hours | 56 | 224 Hours |
| 13 | 52 Hours | 35 | 140 Hours | 57 | 228 Hours |
| 14 | 56 Hours | 36 | 144 Hours (6 Days) | 58 | 232 Hours |
| 15 | 60 Hours | 37 | 148 Hours | 59 | 236 Hours |
| 16 | 64 Hours | 38 | 152 Hours | 60 | 240 Hours (10 Days) |
| 17 | 68 Hours | 39 | 156 Hours | 61 | 244 Hours |
| 18 | 72 Hours (3 Days) | 40 | 160 Hours | 62 | 248 Hours |
| 19 | 76 Hours | 41 | 164 Hours | 63 | 252 Hours |
| 20 | 80 Hours | 42 | 168 Hours (7 Days) | 64 | 256 Hours (10 Days, 16 Hours) |
| 21 | 84 Hours | 43 | 172 Hours | | |
| 22 | 88 Hours | 44 | 176 Hours | | |

NOTE: The chart above applies to the hours in which the control has power. Temperature history data will only be stored when the control has 115V AC supplied to it. If power to the unit is interrupted, the average temperatures for that time period are stored with the event indicator. The temperature history data is stored in a non-volatile memory, so the data is not erased by a power failure, but actual time passage during the power failure will not be shown.

NOTE: Temperature Log Recall Mode is not available for the refrigerator section of the 427R.

MODEL 427R REFRIGERATOR ELECTRONIC CONTROL TERMINOLOGY & COMPONENT DESCRIPTIONS:

The refrigerator section and the wine storage section of the model 427R use separate and unique electronic control systems. Like the wine storage control, the refrigerator electronic control monitors, regulates and controls a variety of functions, to include display of temperatures and possible problems with the unit. But, there is not a temperature alarm associated with the refrigerator electronic control. Instead, a "drawer ajar alarm" is provided. Another difference lies in the display area where an LCD (Liquid Crystal Display) is used, instead of LCD's.

The table below defines some basic 427R refrigerator electronic control system terminology and describes some of the electronic control components. An understanding of the following information is needed in order to comprehend this control system.

| Term/Component | Definition / Description |
|---------------------------------------|---|
| Control Board | The printed-circuit board (PC Board) contains the microprocessor, relays and electrical connections which control and monitor all functions and operations of the unit. |
| Microprocessor | An electrical component on the control board which receives electrical signals from other components, processes that information, then sends an electrical signal to the relays on the board to open or close, and other electronic components in the unit to switch on or off. |
| Relay | The electrical components on the control board which close or open to either allow power to the appropriate component(s), or interrupts power from reaching appropriate component(s). |
| LCD (Liquid Crystal Display) | For our purposes, this is the part of the control panel which electronically displays temperature values and possible error signals. |
| Control Panel Assembly | The information input and read-out area of the electronic control system, located inside the top drawer assembly, at top front. |
| Membrane Switch | An integral part of the control panel assembly, which consists of the function keys used for all input functions to the electronic control system. |
| Keys (Function Keys) | The buttons on the Membrane switch used for input functions. The keys are: UNIT ON/OFF, ALARM (drawer ajar alarm ON/OFF) COLDER, WARMER. |
| Annunciators | The words and numbers that are displayed at the control panel assembly. (Example: Temperature readings, drawer indicator, drawer ajar bell) |
| Set-Point | The desired compartment temperature. This is the approximate average of the high offset and the low offset. |
| High Offset (Cut-in)..... | During normal operation, this is the maximum compartment air temperature that the electronic control system will allow before calling for cooling. |
| Low Offset (Cut-out)..... | During normal operation, this is the minimum compartment air temperature that the electronic control system will allow before interrupting cooling. |
| Offset Temperature Range | The difference between the low offset and the high offset. |
| Thermistor (Temperature Sensor) | A resistor with which resistance changes as the temperature around it changes. For electronic control system purposes, the microprocessor deciphers this resistance as temperature. |

MODEL 427R BASIC REFRIGERATOR ELECTRONIC CONTROL SYSTEM:

Input operations for the refrigerator electronic control system are performed at the control panel, with monitoring, regulating and controlling functions taking place at the control board. Temperatures and possible problems with the unit are displayed at the control panel LCD. The diagrams on this page illustrate the refrigerator electronic control system. (See Figure 3-53 for units prior to serial #1944319, see Figure 3-54 for units starting with serial #1944319.) The entire 427R refrigerator electronic control system is described in greater detail following in this page.

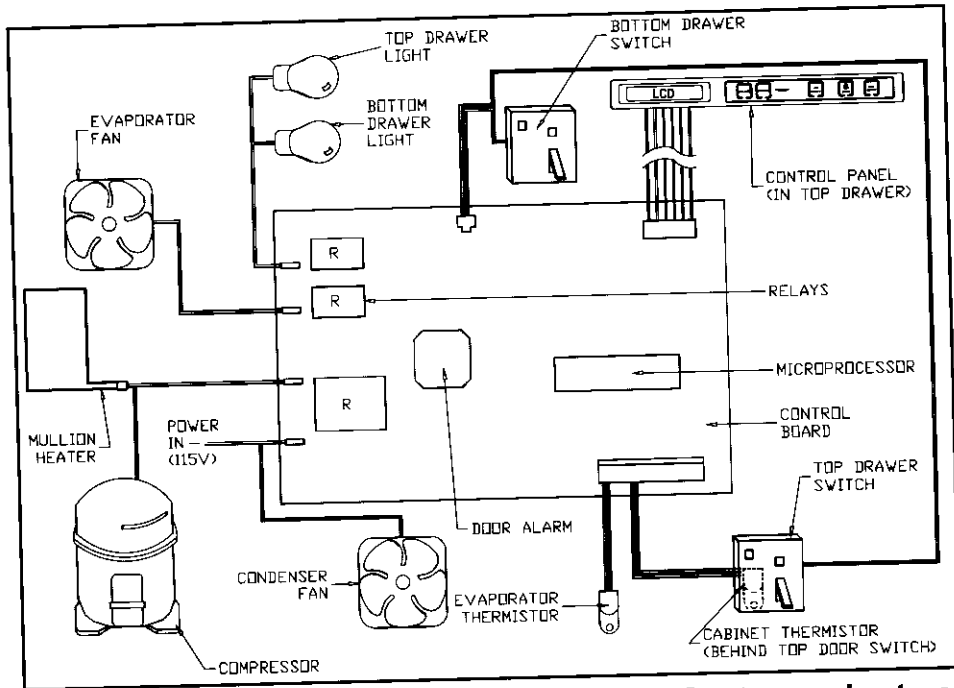

Figure 3-53. Model 427R Refrigerator Electronic Control System, prior to serial #1944319

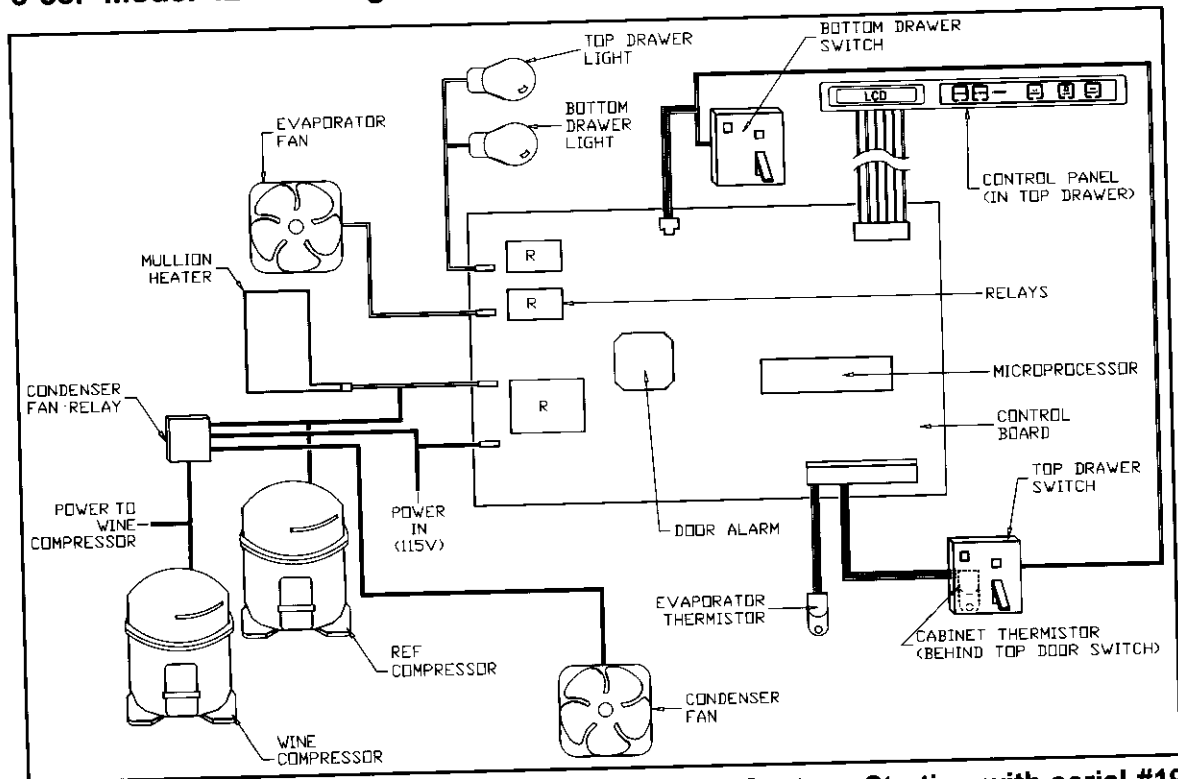

Figure 3-54. Model 427R Refrigerator Electronic Control System, Starting with serial #1944319

MODEL 427R REFRIGERATOR CONTROL BOARD LAYOUT / SUMMARY TABLE:

The electrical connection points on the 427R refrigerator control board are labeled Alphanumerically. These labels correspond with the alphanumeric control board summary table, located on the 427R wiring diagram. By referencing the summary table, it is possible to identify which components are connected at which connection points on the control board. Below is a layout diagram of the control board, followed by a copy of a summary table. (See Figures 3-55 and 3-56)

NOTE: All components on the control board are non-replaceable. If a problem with the control board is identified, the complete control board must be replaced.

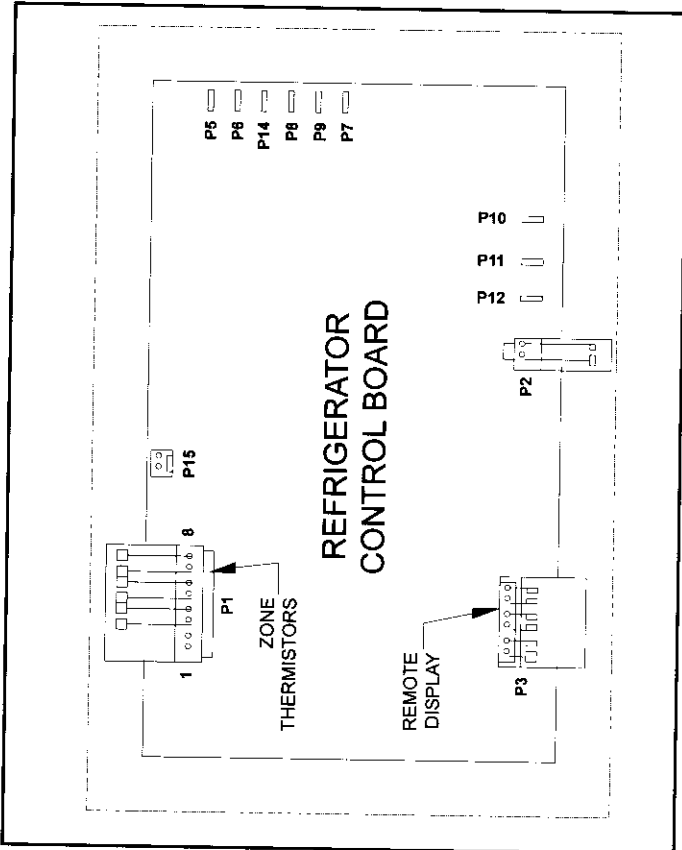

Figure 3-55. Model 427R Refrigerator Control Board Layout

| TERM. | NO# | DESCRIPTION | FUNCTION | COLOR |
|-------|-----|---------------------|--------------------|-------------------|
| P1 | 1 | THERMISTOR CIRCUITS | EMPTY | EMPTY |
| | 2 | EMPTY | EMPTY | EMPTY |
| | 3 | EMPTY | EMPTY | EMPTY |
| | 4 | EMPTY | EMPTY | EMPTY |
| | 5 | DRAWER | SENSES TEMPERATURE | LT. BLUE W/BLACK |
| | 6 | DRAWER | SENSES TEMPERATURE | LT. BLUE W/BLACK |
| | 7 | EVAPORATOR | SENSES TEMPERATURE | LT. BLUE W/BLACK |
| | 8 | EVAPORATOR | SENSES TEMPERATURE | LT. BLUE W/YELLOW |
| P3 | 1 | DISPLAY BOARD | DISPLAY BOARD | BLACK |
| | 2 | " | " | WHITE |
| | 3 | " | " | RED |
| | 4 | " | " | YELLOW |
| | 5 | " | " | ORANGE |
| | 6 | " | " | BLUE |

AUXILIARY CHART

| TERM. | DESCRIPTION | FUNCTION | COLOR |
|-------|-----------------|------------------------|----------------|
| P1 | THERMISTORS | SENSES TEMPERATURES | SEE AUX. CHART |
| P2 | LIGHT SWITCH | CONTROLS LIGHTS | WHITE/RED |
| P3 | REMOTE DISPLAY | CONNECTS TO DISPLAY | SEE AUX. CHART |
| P5 | L2-NEUTRAL 115 | NEUTRAL INTO THE BOARD | WHITE |
| P6 | L1-HOT 115 | POWER INTO BOARD | BLACK |
| P7 | LIGHTS-120V OUT | POWERS LIGHTS | ORANGE |
| P8 | EVAPORATOR FAN | POWERS FANS | RED |
| P14 | COMPRESSOR | POWERS COMPRESSOR | PURPLE |

Figure 3-56. Model 427R Refrigerator Control Board Summary Table

427R REFRIGERATOR CONTROL PANEL LAYOUT:

Starting with serial #1728753, the control panel assembly was upgraded with a membrane switch. The diagrams below show the two different control panel assemblies found in the 427R refrigerator section. (See Figure 3-57 for units prior to serial #1728753. See Figure 3-58 for units starting with serial #1728753.)

NOTE: All model 427R refrigerator control panel diagrams following this page will be that of units starting with serial #1728753.

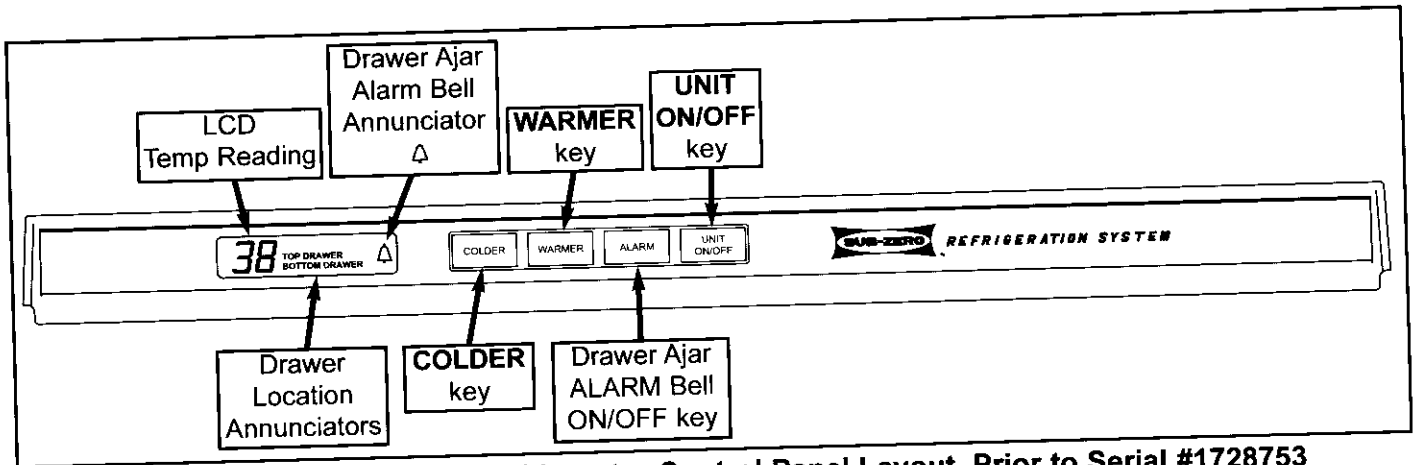

Figure 3-57. Model 427R Refrigerator Control Panel Layout, Prior to Serial #1728753

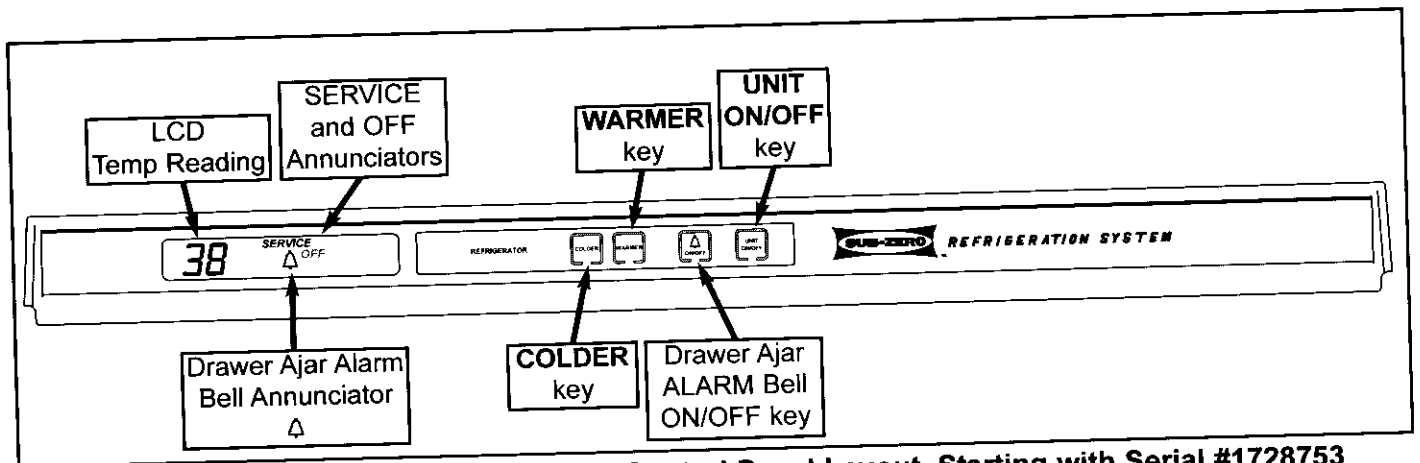

Figure 3-58. Model 427R Refrigerator Control Panel Layout, Starting with Serial #1728753

427R REFRIGERATOR BASIC ELECTRONIC CONTROL INPUT OPERATIONS:

This section illustrates the basic input operations performed at the 427R refrigerator control panel. Switching the refrigerator section ON and OFF, adjusting the refrigerator set-point (temperature adjustments), and enabling / disabling the drawer ajar alarm will be explained.

Model 427R Refrigerator Section ON/OFF

When shipped from the factory, the refrigerator section of the model 427R is in the Off Mode. By pressing and releasing the UNIT ON/OFF key in the refrigerator section (See Figure 3-59), power is allowed past the control board to the rest of the refrigerator section. This will be indicated by the unit lights and LCD energizing.

⚠ WARNING

WHEN IN OFF MODE, 115 VOLTS AC IS STILL PRESENT AT CONTROL BOARD.

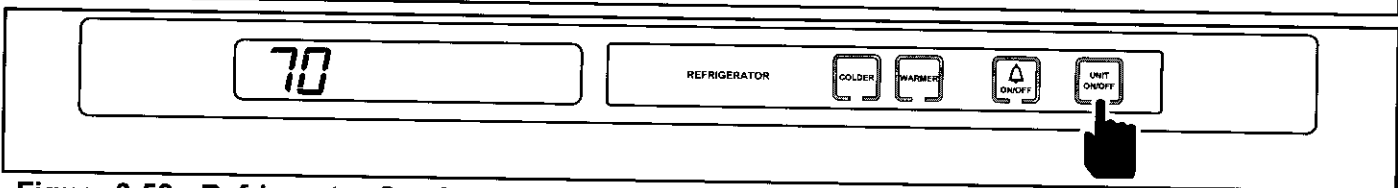

Figure 3-59. Refrigerator Section ON/OFF, Press UNIT ON/OFF Key on Refrigerator Control Panel

Adjusting Model 427R Refrigerator Section Set-Points (Temperature Adjustments)

To adjust set-point, press the WARMER or COLDER key in multiple key strokes until the desired temperature is achieved (See Figure 3-60).

NOTE: The temperature range in the refrigerator drawer section is 34°F / 1°C to 45°F / 7°C.

NOTE: The initial key stroke of the WARMER or COLDER keys will change the previous set-point.

NOTE: The set-point will be displayed for 10 seconds after the last WARMER or COLDER key stroke. After the 10 second delay, the compartment temperature will be displayed. As the compartment temperature changes, the temperature displayed will change by no more than 1° per minute.

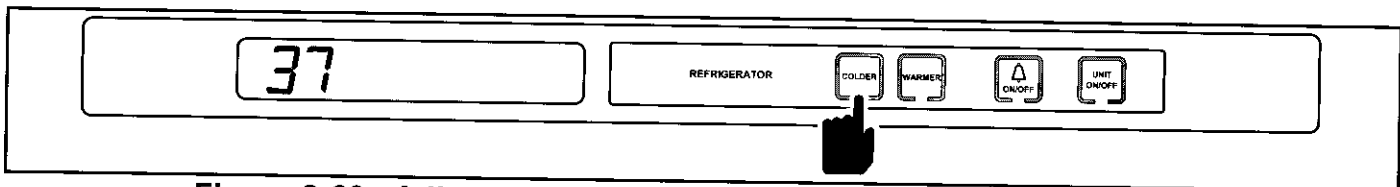
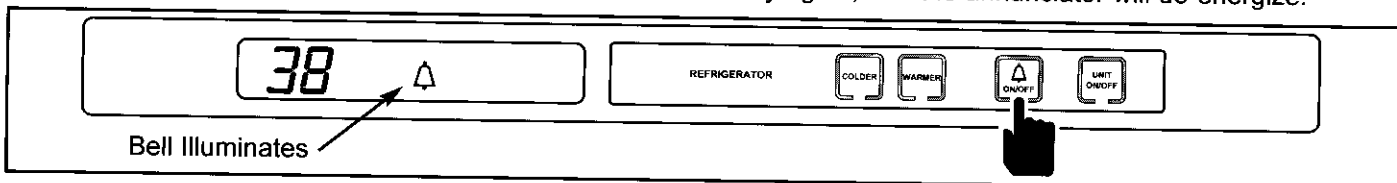

Figure 3-60. Adjusting Set-Point, Press COLDER or WARMER Key

Model 427R Refrigerator Drawer Ajar Alarm ON/OFF

The 427R has an audio/visual drawer ajar alarm that can be enabled to warn the customer if a drawer is left open. When enabled, the alarm will beep if a drawer is open for more than 15 seconds.

To enable the alarm, press and release the Bell ON/OFF key (See Figure 3-61). Prior to serial #1728753, press the "ALARM" key. When enabled, the drawer ajar alarm (bell) annunciator will illuminate. To disable the drawer ajar alarm, simply press and release the ALARM or Bell ON/OFF key again, and the annunciator will de-energize.



**Figure 3-61. Drawer Ajar Alarm ON/OFF, Press Bell ON/OFF key
(Prior to Serial #1728753, press the "ALARM" key)**